

OrangeBook Jr. INDEX



Bearings • Driving Equipments • Transmission Parts ▶▶285

Ball Bearings	285~	Machine Keys	307~
Roller Bearings	287~	Chains • Sprockets	309~
Roller Followers	288	Belts	323
Cam Followers	288	Pulleys	323~
Nuts for Bearings	289		
Guide Rollers	289~		
Resin Bearings	290~		
Metal Bearings	291~		
Bearing Units	292~		
Sliding Bearings	293~		
Rod Ends	303~		
Motors	305		
Gears	305~		
Couplings	306		
Shaft Collars	307		



Machine Parts ▶▶325

O-Rings • Oil Seals	325~	Oil Tank Caps	357~
Rubbers	329~	Knobs	358~
Resins	331~	Levers	365
Metal Materials	333	Grip Handles	365~
Vibration Absorber	334~	Handles	368~
Adjusters	340~	Hinges	370~
Plungers	343~	Slide Rails	372
Springs for Die	347~	Stays	373
Springs	349~	Toggle Latches	374~
Split Pins	350~	Fastening Parts	376
Snap Rings	353~	Aluminum Frames	377~
Oil Gauges	355~		



Screws • Bolts • Nuts ▶▶379

Hexagon Bolts	379~	Screws for Woodworking	432~
Hexagon Socket Head Cap Screws	384~	Screws for Construction	434
Hexagon Socket Set Screws	394~	Nails	434
Wing Bolts	396~		
Decoration Screws, Nuts	397~		
Nuts	402~		
Caps for Screw	409~		
Washers	410~		
Small Screws	414~		
Mischief Prevention Screws	422~		
Drill Screws	425~		
Tapping Screws	428~		



Fasteners ▶▶435

Anchors	435~	Plugs	450~
Adhesive Anchors	443	Nail Plugs	451~
Tools for Anchor	443	Blind Rivet	453~
Plugless Anchors	444~	Riveters	456~
ALC Anchors	446	Blind Nuts	458~
Board Anchors	447	Nut Insert Tools	462
Hollow Wall Anchors	448~	Eyelet • Eyelet Punches	463~

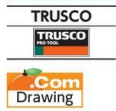

TKH-90CNA

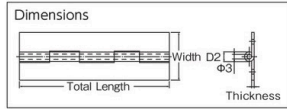

Hinge (stainless steel SUS304)

ข้อมูลจำเพาะ ●กรรมวิธีอบชุบผิว: ผิวสำเร็จแบบ Buffed mirror
●วิธีการติดตั้ง: เชื่อม

ประเทศที่ผลิต ●จีน

Order Unit: 1 Pcs

		TRUSCO NAKAYAMA CORPORATION						
Order Code	Item No.	Price (per pcs)	Total Length (mm)	Width (mm)	Thickness (mm)	D2 (mm)	Load Capacity (kg) when 2 pieces used	Weight (g)
279-6180	TKH-25CNA	130THB	25	32	1.5	6.3	3	14
279-6198	TKH-30CNA	136THB	30	32	1.5	6.3	4	17
279-6201	TKH-40CNA	145THB	40	32	1.5	6.3	6	22
279-6210	TKH-50CNA	155THB	50	32	1.5	6.3	7	28
279-6228	TKH-60CNA	179THB	60	32	1.5	6.3	9	33
279-6236	TKH-65CNA	192THB	65	32	1.5	6.3	10	36
279-6244	TKH-75CNA	209THB	75	32	1.5	6.3	11	42
279-6252	TKH-80CNA	215THB	80	32	1.5	6.3	12	45
279-6261	TKH-90CNA	236THB	90	32	1.5	6.3	13	50
279-6279	TKH-100CNA	243THB	100	32	1.5	6.3	15	56



C2721-45

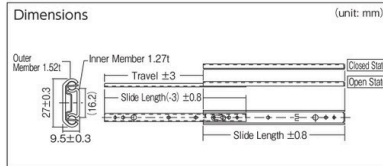

Single Slide Rail "C2721" (for light load)

ข้อมูลจำเพาะ ●สำหรับโหลดเบา
●แบบ 2 ชั้นส่วนเคลื่อนที่ 3/4
●ชิ้นส่วนภายในไม่สามารถถอดออกได้
●แบบหยุด

วัสดุ ●กรรมวิธีอบชุบผิว: ผิวสำเร็จชุบโครเมียมไตรวาเลนท์
ประเทศที่ผลิต ●ญี่ปุ่น

Order Unit: 1 Pcs

		ACCURIDE JAPAN Co.Ltd.			
Order Code	Item No.	Price (per pcs)	W x H x L x moving distance (mm)	Rated Load (N) pair/vertical	Weight (kg)
233-8653	C2721-20	423THB	9.5 x 27 x 200 x 134	255	0.28
233-8661	C2721-25	459THB	9.5 x 27 x 250 x 184	235	0.36
233-8670	C2721-30	483THB	9.5 x 27 x 300 x 221	235	0.44
233-8688	C2721-35	499THB	9.5 x 27 x 350 x 259	226	0.52
233-8696	C2721-40	513THB	9.5 x 27 x 400 x 296	206	0.60
233-8700	C2721-45	540THB	9.5 x 27 x 450 x 333	196	0.68
233-8718	C2721-50	587THB	9.5 x 27 x 500 x 371	177	0.76

⚠ ข้อควรระวัง
●เมื่อใช้ในจำนวน โหลดที่กำหนดเป็น 1/4 ของการแสดงผล

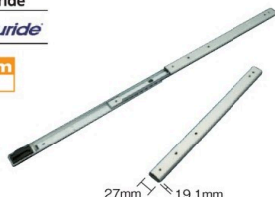

C2731-255C

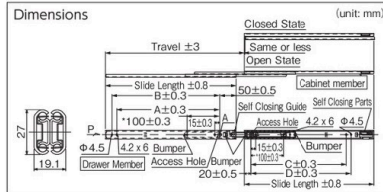

Self-closing Slide Rail "C2731" (for light load)

คุณสมบัติ ●เมื่อปิดสนิท ชัก มันมีกลไกการปิดด้วยตัวเองที่ปิดโดยสมบูรณ์แม้มันจะไม่ถูกผลักให้หลุด

ข้อมูลจำเพาะ ●สำหรับโหลดเบา ●แบบ 3 ชั้นส่วนเคลื่อนที่เต็ม
●ชิ้นส่วนของลิ้นชักไม่สามารถถอดออกได้ ●ปิดด้วยตัวเอง

วัสดุ ●กรรมวิธีอบชุบผิว: ผิวสำเร็จชุบโครเมียมไตรวาเลนท์

ประเทศที่ผลิต ●ญี่ปุ่น

Order Unit: 1 Pcs

		ACCURIDE JAPAN Co.Ltd.			
Order Code	Item No.	Price (per pcs)	W x H x L x moving distance (mm)	Rated Load (N) pair/vertical	Weight (kg)
470-6358	C2731-255C	970THB	19.1 x 27 x 250 x 278	290	0.35
470-6366	C2731-30SC	1,070THB	19.1 x 27 x 300 x 327	318	0.43
470-6374	C2731-35SC	1,117THB	19.1 x 27 x 350 x 376	300	0.51
470-6382	C2731-40SC	1,171THB	19.1 x 27 x 400 x 426	283	0.59
470-6391	C2731-45SC	1,217THB	19.1 x 27 x 450 x 475	265	0.67
470-6404	C2731-50SC	1,271THB	19.1 x 27 x 500 x 524	248	0.75

⚠ ข้อควรระวัง
●เมื่อใช้ในจำนวน โหลดที่กำหนดเป็น 1/4 ของการแสดงผล

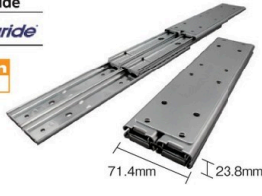

C501-18

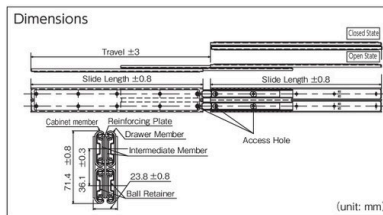

Double Slide Rail "C501" (for heavy load)

ข้อมูลจำเพาะ ●สำหรับโหลดหนัก
●แบบ 3 ชั้นส่วนเคลื่อนที่เต็ม
●ชิ้นส่วนของลิ้นชักไม่สามารถถอดออกได้
●แบบหยุด

วัสดุ ●กรรมวิธีอบชุบผิว: ผิวสำเร็จชุบโครเมียมไตรวาเลนท์

ประเทศที่ผลิต ●ญี่ปุ่น

Order Unit: 1 Pcs

		ACCURIDE JAPAN Co.Ltd.			
Order Code	Item No.	Price (per pcs)	W x H x L x moving distance (mm)	Rated Load (N) pair/vertical	Weight (kg)
327-2931	C501-12	4,119THB	23.8 x 71.4 x 304.8 x 327	2667	3.99
327-2940	C501-14	3,953THB	23.8 x 71.4 x 355.6 x 378	2628	4.67
327-2958	C501-16	4,170THB	23.8 x 71.4 x 406.4 x 429	2540	5.35
327-2966	C501-18	4,504THB	23.8 x 71.4 x 457.2 x 479	2452	6.03
327-2974	C501-20	5,236THB	23.8 x 71.4 x 508.0 x 530	2363	6.67
327-2982	C501-22	5,140THB	23.8 x 71.4 x 558.8 x 581	2246	7.36
327-2991	C501-24	5,547THB	23.8 x 71.4 x 609.6 x 632	2118	8.04
327-3008	C501-26	5,923THB	23.8 x 71.4 x 660.4 x 683	1961	8.72
327-3016	C501-28	6,409THB	23.8 x 71.4 x 711.2 x 733	1785	9.35

⚠ ข้อควรระวัง
●เมื่อใช้ในจำนวน โหลดที่กำหนดเป็น 1/4 ของการแสดงผล

รหัสสั่งซื้อ **สีน้ำเงิน** ... มีสินค้าสต็อกที่ประเทศอินโดนีเซียและประเทศไทย **สีแดง** ... มีสินค้าสต็อกที่ประเทศอินโดนีเซีย **สีเขียว** ... มีสินค้าสต็อกที่ประเทศไทย

- O-Rings·Oil Seals
- Rubbers
- Resins
- Metal Materials
- Vibration Absorber
- Adjusters
- Plungers
- Spring for Die
- Spring
- Split Pins
- Snap Rings
- Oil Gauges
- Oil Tank Caps
- Knobs
- Levers
- Grip Handles
- Handles
- Hinges
- Slide Rails
- Stays
- Toggle Latches
- Fastening Parts
- Aluminum Frames

353 Machine Parts

- O-Rings· Oil Seals
- Rubbers
- Resins
- Metal Materials
- Vibration Absorber
- Adjusters
- Plungers
- Springs for Die
- Springs
- Split Pins
- Snap Rings
- Oil Gauges
- Oil Tank Caps
- Knobs
- Lever
- Grip Handles
- Handles
- Hinges
- Slide Rails
- Stays
- Toggle Latches
- Fastening Parts
- Aluminum Frames

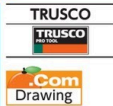

B34 Type (steel)



B92 Type (stainless steel)

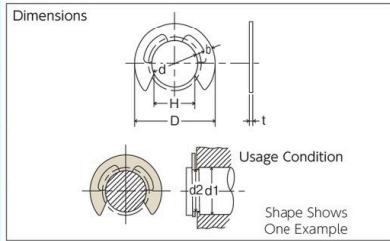

E-ring

ประเทศไทยผลิต ญี่ปุ่น

Steel วัสดุ

- เหล็กสำหรับสปริง (S50C ถึง S70C หรือวัสดุที่เทียบเท่า SK)
- กรรมวิธีอบชุบผิว: ชุบเคลือบผิวด้วยโครเมียมโครวาเลนซ์

TRUSCO NAKAYAMA CORPORATION

Order Code	Item No.	Price (per pack)	Nominal Diameter	Retaining Ring (mm)						Q'ty Per Pack (pcs)	Weight (g)
				D	H	t	b	d1	d2		
161-3146	B34-0002	178THB	E-2.0	5	1.7	0.4	0.7	2.5	2.0	330	14.8
161-3154	B34-0025	178THB	E-2.5	6	2.1	0.4	0.8	3.2	2.5	300	18.3
161-3162	B34-0003	178THB	E-3.0	7	2.6	0.6	0.9	4.0	3.0	300	32.1
161-3171	B34-0004	178THB	E-4.0	9	3.5	0.6	1.1	5.0	4.0	230	39.1
161-3189	B34-0005	178THB	E-5.0	11	4.3	0.6	1.2	6.0	5.0	200	42.0
161-3197	B34-0006	178THB	E-6.0	12	5.2	0.8	1.4	7.0	6.0	140	42.1
161-3201	B34-0007	178THB	E-7.0	14	6.1	0.8	1.6	8.0	7.0	70	31.7
161-3219	B34-0008	178THB	E-8.0	16	6.9	0.8	1.8	9.0	8.0	60	33.1
161-3227	B34-0009	178THB	E-9.0	18	7.8	0.8	2.0	10.0	9.0	40	34.0
161-3235	B34-0010	178THB	E-10.0	20	8.7	1.0	2.2	11.0	10.0	40	42.2
161-3243	B34-0012	178THB	E-12.0	23	10.4	1.0	2.4	13.0	12.0	30	38.9
161-3251	B34-0015	178THB	E-15.0	29	13.0	1.5	2.8	16.0	15.0	10	31.4
161-3260	B34-0019	178THB	E-19.0	37	16.5	1.5	4.0	20.0	19.0	7	36.7
161-3278	B34-0024	178THB	E-24.0	44	20.8	2.0	5.0	25.0	24.0	5	50.0

Stainless Steel วัสดุ

• เหล็กกล้าไร้สนิม (SUS304CSP)

TRUSCO NAKAYAMA CORPORATION

Order Code	Item No.	Price (per pack)	Nominal Diameter	Retaining Ring (mm)						Q'ty Per Pack (pcs)	Weight (g)
				D	H	t	b	d1	d2		
213-0173	B92-0002	182THB	E-2.0	5	1.7	0.4	0.7	2.5	2.0	400	18.0
213-0181	B92-0025	182THB	E-2.5	6	2.1	0.4	0.8	3.2	2.5	350	21.3
213-0190	B92-0003	182THB	E-3.0	7	2.6	0.6	0.9	4.0	3.0	230	24.6
213-0203	B92-0004	182THB	E-4.0	9	3.5	0.6	1.1	5.0	4.0	180	30.6
213-0211	B92-0005	182THB	E-5.0	11	4.3	0.6	1.2	6.0	5.0	140	29.4
213-0220	B92-0006	182THB	E-6.0	12	5.2	0.8	1.4	7.0	6.0	100	30.1
213-0238	B92-0007	182THB	E-7.0	14	6.1	0.8	1.6	8.0	7.0	60	27.1
213-0254	B92-0008	182THB	E-8.0	16	6.9	0.8	1.8	9.0	8.0	50	27.6
213-0262	B92-0009	182THB	E-9.0	18	7.8	0.8	2.0	10.0	9.0	40	34.0
213-0271	B92-0010	182THB	E-10.0	20	8.7	1.0	2.2	11.0	10.0	30	31.7
213-0297	B92-0012	182THB	E-12.0	23	10.4	1.0	2.4	13.0	12.0	23	29.8
213-0301	B92-0015	182THB	E-15.0	29	13.0	1.5	2.8	16.0	15.0	6	18.8
213-0319	B92-0019	182THB	E-19.0	37	16.5	1.5	4.0	20.0	19.0	4	21.0

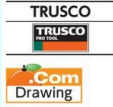

(B32-0005 to B32-0009)



(B32-0010 to B32-0050)

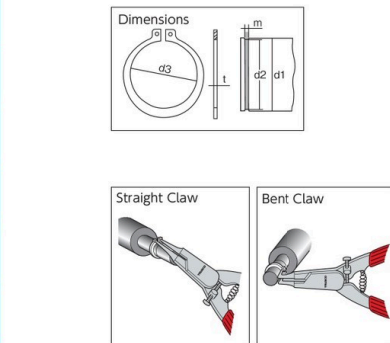

Snap Ring (for shaft)

คุณสมบัติ • ที่หางปลา (มีรูสำหรับคีมจับ) ทำให้ง่ายต่อการใส่และถอด

- เหล็กกล้าสำหรับสปริง (S65C เทียบเท่า)
- กรรมวิธีอบชุบผิว: การอบชุบ ACP

ประเทศไทยผลิต ญี่ปุ่น

TRUSCO NAKAYAMA CORPORATION

Order Code	Item No.	Price (per pack)	Nominal Diameter	Retaining Ring (mm)			Applicable Axis (reference) (mm)			Q'ty Per Pack (pcs)	Weight (g)
				d3	t	d1	d2	m			
160-9378	B32-0005	178THB	S-5	4.7	0.6	5	4.8	0.70	90	7.2	
160-9386	B32-0006	178THB	S-6	5.6	0.7	6	5.7	0.80	90	10.8	
160-9394	B32-0008	178THB	S-8	7.4	0.8	8	7.6	0.90	80	16.0	
160-9408	B32-0009	178THB	S-9	8.4	1.0	9	8.6	1.15	60	18.0	
160-9416	B32-0010	178THB	S-10	9.3	1.0	10	9.6	1.15	53	20.0	
160-9424	B32-0011	178THB	S-11	10.2	1.0	11	10.5	1.15	51	23.1	
160-9432	B32-0012	178THB	S-12	11.1	1.0	12	11.5	1.15	49	24.7	
160-9441	B32-0013	178THB	S-13	12.0	1.0	13	12.4	1.15	47	25.5	
160-9459	B32-0014	178THB	S-14	12.9	1.0	14	13.4	1.15	40	25.7	
160-9467	B32-0015	178THB	S-15	13.8	1.0	15	14.3	1.15	39	26.2	
160-9475	B32-0016	178THB	S-16	14.7	1.0	16	15.2	1.15	33	23.9	
160-9483	B32-0017	178THB	S-17	15.7	1.0	17	16.2	1.15	33	25.8	
160-9491	B32-0018	178THB	S-18	16.5	1.2	18	17.0	1.35	28	32.0	
160-9505	B32-0019	178THB	S-19	17.5	1.2	19	18.0	1.35	28	33.6	
160-9513	B32-0020	178THB	S-20	18.5	1.2	20	19.0	1.35	24	31.3	
160-9521	B32-0021	178THB	S-21	19.5	1.2	21	20.0	1.35	22	30.1	
160-9530	B32-0022	178THB	S-22	20.5	1.2	22	21.0	1.35	20	29.0	
160-9548	B32-0023	178THB	S-23	21.4	1.2	23	22.0	1.35	19	28.5	
164-3002	B32-0024	178THB	S-24	22.2	1.2	24	22.9	1.35	19	33.3	
160-9556	B32-0025	178THB	S-25	23.2	1.2	25	23.9	1.35	19	34.0	
160-9564	B32-0026	178THB	S-26	24.2	1.2	26	24.9	1.35	17	32.3	
160-9572	B32-0027	178THB	S-27	25.0	1.2	27	25.8	1.35	14	28.0	
160-9581	B32-0028	178THB	S-28	25.9	1.5	28	26.6	1.75	12	30.5	
160-9599	B32-0030	178THB	S-30	27.9	1.5	30	28.6	1.75	12	36.8	
160-9602	B32-0032	178THB	S-32	29.6	1.5	32	30.3	1.75	10	33.9	
160-9611	B32-0034	178THB	S-34	31.5	1.5	34	32.3	1.75	9	34.7	
160-9629	B32-0035	178THB	S-35	32.2	1.5	35	33.0	1.75	8	32.2	
160-9637	B32-0036	178THB	S-36	33.2	1.8	36	34.0	1.95	7	33.6	
160-9645	B32-0038	178THB	S-38	35.2	1.8	38	36.0	1.95	7	39.6	
160-9653	B32-0040	178THB	S-40	37.0	1.8	40	38.0	1.95	7	39.9	
160-9661	B32-0042	178THB	S-42	38.5	1.8	42	39.5	1.95	6	36.0	
160-9670	B32-0045	178THB	S-45	41.5	1.8	45	42.5	1.95	6	40.8	
160-9688	B32-0047	178THB	S-47	43.4	1.8	47	44.5	1.95	5	35.5	
160-9696	B32-0048	178THB	S-48	44.5	1.8	48	45.5	1.95	5	37.5	
160-9700	B32-0050	178THB	S-50	45.8	2.0	50	47.0	2.20	4	35.6	

353

สินค้าบางรายการไม่สามารถนำเข้าได้ สินค้าบางรายการไม่สามารถใช้กับไฟฟ้ไทยได้ ราคาไม่รวมภาษีมูลค่าเพิ่ม

349 Machine Parts

- O-Rings· Oil Seals
- Rubbers
- Resins
- Metal Materials
- Vibration Absorber
- Adjusters
- Plungers
- Springs for Die
- Springs
- Split Pins
- Snap Rings
- Oil Gauges
- Oil Tank Caps
- Knobs
- Lever
- Grip Handles
- Handles
- Hinges
- Slide Rails
- Stays
- Toggle Latches
- Fastening Parts
- Aluminum Frames



TS-A Type (arm angle 90°)

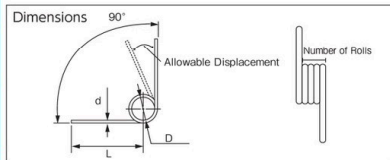

*Allowable displacement amount is set when used in the direction to close the arm angle. When used in the direction to open the arm, please use less than allowable displacement x 75%.

Item No. Example
TS - 33001 R A
 Size: TS-33001, Winding direction: R, Arm angle/Type: A: 90° Type, B: 135° Type

Torsion Spring (stainless steel)

- คุณสมบัติ
- สปริงเชิงกลที่ขดเป็นทรงกระบอกซึ่งใช้พันเข้ากับแกนขดลวด
 - เมื่อถูกใช้เพื่อปิดมุมของแขนยึด เส้นผ่านศูนย์กลางของแตรรองรับสปริงจะมีขนาดเป็น 90% ของเส้นผ่านศูนย์กลางภายในของขดลวดเมื่อมีการรับน้ำหนักสูงสุด เนื่องจากเส้นผ่านศูนย์กลางของขดลวดจะมีขนาดลดลง
 - สปริงต้องการพลังในการยึดและคืนตัวของก๊ีบ

- ข้อมูลจำเพาะ
- มุมของแขน: 90°
 - วัสดุ: ●เหล็กกล้าไร้สนิม (SUS304-WPB)
 - ประเทศที่ผลิต: ●ญี่ปุ่น

Order Unit: 1 Pack

TRUSCO NAKAYAMA CORPORATION

Order Code	Item No.	Price (per pack)	d (mm)	Mechanical Spring Constant (N·mm/deg)	Allowable Displacement Amount (°)	D (mm)	L (mm)	Number of Rolls (roll)	Qty Per Pack (pcs)	Weight (g)
160-5324	TS-33001RA	830THB	0.3	0.05	56	3	12	2	20	9
160-5327	TS-33010RA	830THB	0.5	0.26	52	3	12	3	20	9
160-5330	TS-33022RA	830THB	0.6	0.41	55	4	16	3	20	11
160-5333	TS-33024RA	830THB	0.6	0.26	89	4	16	5	20	13
160-5336	TS-33028RA	830THB	0.5	0.10	128	5	20	5	20	13
160-5339	TS-33031RA	830THB	0.6	0.26	88	5	20	4	20	13
160-5342	TS-33032RA	830THB	0.6	0.21	109	5	20	5	20	15
160-5345	TS-33033RA	830THB	0.8	1.44	33	5	20	2	20	15
160-5348	TS-33036RA	830THB	0.8	0.65	80	5	20	5	20	19
160-5351	TS-33040RA	830THB	0.6	0.18	128	6	24	5	10	11
160-5726	TS-33045RA	830THB	1.0	2.91	32	6	24	2	10	14
160-5727	TS-33048RA	830THB	1.0	1.32	78	6	24	5	10	18
160-5728	TS-33049RA	830THB	0.7	0.63	51	7	28	2	10	11
160-5729	TS-33051RA	830THB	0.7	0.35	98	7	28	4	10	12
160-5730	TS-33056RA	830THB	0.9	0.77	97	7	28	5	10	17
160-5731	TS-33057RA	830THB	1.2	5.17	30	7	28	2	10	18
160-5732	TS-33060RA	830THB	1.2	2.34	72	7	28	5	10	25
160-5733	TS-33071RA	830THB	1.2	2.55	65	8	32	4	10	25
160-5734	TS-33076RA	830THB	0.9	0.61	122	9	36	5	5	17
160-5735	TS-33081RA	830THB	1.4	7.53	32	9	36	2	5	33
160-5736	TS-33084RA	830THB	1.4	3.42	78	9	36	5	5	48
160-5737	TS-33087RA	830THB	1.0	1.02	98	10	40	4	5	44
160-5738	TS-33100RA	830THB	1.2	1.45	115	12	40	5	2	25
160-5739	TS-33101RA	830THB	1.6	9.80	35	12	48	2	2	19
160-5740	TS-33103RA	830THB	1.6	5.44	68	12	48	4	2	23
160-5741	TS-33105RA	830THB	1.8	15.49	32	12	48	2	2	19
160-5742	TS-33111RA	830THB	1.4	2.81	93	14	56	4	2	28
160-5743	TS-33112RA	830THB	1.4	2.30	115	14	56	5	2	30
160-5744	TS-33116RA	830THB	1.8	6.14	87	14	56	5	2	30
160-5745	TS-33117RA	830THB	2.0	20.36	33	14	56	2	2	24
160-5749	TS-33118RA	830THB	2.0	14.53	48	14	56	3	2	26

ข้อมูลจำเพาะ ●มุมของแขน: 135°

Order Unit: 1 Pack

Order Code	Item No.	Price (per pack)	d (mm)	Mechanical Spring Constant (N·mm/deg)	Allowable Displacement Amount (°)	D (mm)	L (mm)	Number of Rolls (roll)	Qty Per Pack (pcs)	Weight (g)
160-5325	TS-33001RB	830THB	0.3	0.05	56	3	12	2	20	9
160-5328	TS-33010RB	830THB	0.5	0.26	52	3	12	3	20	9
160-5331	TS-33022RB	830THB	0.6	0.41	55	4	16	3	20	11
160-5334	TS-33024RB	830THB	0.6	0.26	89	4	16	5	20	13
160-5337	TS-33028RB	830THB	0.5	0.10	128	5	20	5	20	13
160-5340	TS-33031RB	830THB	0.6	0.26	88	5	20	4	20	13
160-5343	TS-33032RB	830THB	0.6	0.21	109	5	20	5	20	15
160-5346	TS-33033RB	830THB	0.8	1.44	33	5	20	2	20	15
160-5349	TS-33036RB	830THB	0.8	0.65	80	5	20	5	20	19
160-5352	TS-33040RB	830THB	0.6	0.18	128	6	24	5	10	11
160-5750	TS-33045RB	830THB	1.0	2.91	32	6	24	2	10	14
160-5751	TS-33048RB	830THB	1.0	1.32	78	6	24	5	10	18
160-5752	TS-33049RB	830THB	0.7	0.63	51	7	28	2	10	11
160-5753	TS-33051RB	830THB	0.7	0.35	98	7	28	4	10	12
160-5754	TS-33056RB	830THB	0.9	0.77	97	7	28	5	10	17
160-5755	TS-33057RB	830THB	1.2	5.17	30	7	28	2	10	18
160-5756	TS-33060RB	830THB	1.2	2.34	72	7	28	5	10	25
160-5757	TS-33071RB	830THB	1.2	2.55	65	8	32	4	10	25
160-5758	TS-33076RB	830THB	0.9	0.61	122	9	36	5	5	17
160-5759	TS-33081RB	830THB	1.4	7.53	32	9	36	2	5	33
160-5760	TS-33084RB	830THB	1.4	3.42	78	9	36	5	5	48
160-5761	TS-33087RB	830THB	1.0	1.02	98	10	40	4	5	44
160-5762	TS-33100RB	830THB	1.2	1.45	115	12	40	5	2	25
160-5764	TS-33101RB	830THB	1.6	9.80	35	12	48	2	2	19
160-5765	TS-33103RB	830THB	1.6	5.44	68	12	48	4	2	23
160-5766	TS-33105RB	830THB	1.8	15.49	32	12	48	2	2	19
160-5767	TS-33111RB	830THB	1.4	2.81	93	14	56	4	2	28
160-5768	TS-33112RB	830THB	1.4	2.30	115	14	56	5	2	30
160-5769	TS-33116RB	830THB	1.8	6.14	87	14	56	5	2	30
160-5770	TS-33117RB	830THB	2.0	20.36	33	14	56	2	2	24
160-5771	TS-33118RB	830THB	2.0	14.53	48	14	56	3	2	26

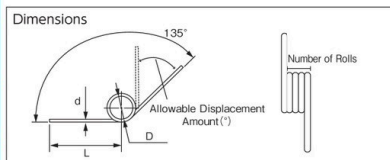

*Allowable displacement amount is set when used in the direction to close the arm angle. When used in the direction to open the arm, please use less than allowable displacement x 75%.

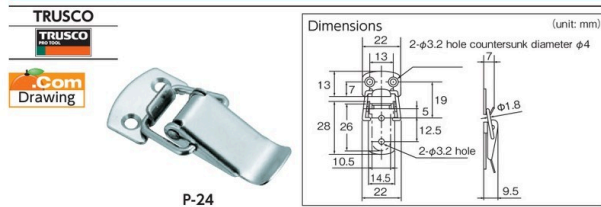

Draw Latch (standard type, steel)

วัสดุ ●กรรมวิธีอบชุบผิว: ผิวสำเร็จชุบนิเกิล ประเทศที่ผลิต ●ญี่ปุ่น

TRUSCO NAKAYAMA CORPORATION				
Order Code	Item No.	Price (per pack)	Q'ty Per Pack (pcs)	Weight (g)
232-7911	P-24	169THB	4	50

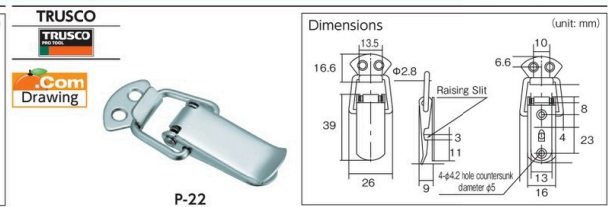

Draw Latch (standard type, steel)

วัสดุ ●กรรมวิธีอบชุบผิว: ผิวสำเร็จชุบนิเกิล ประเทศที่ผลิต ●ญี่ปุ่น

TRUSCO NAKAYAMA CORPORATION				
Order Code	Item No.	Price (per pack)	Q'ty Per Pack (pcs)	Weight (g)
232-8178	P-22	275THB	4	80

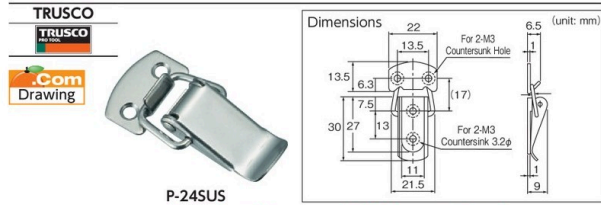

Draw Latch (standard type, stainless steel)

ประเทศที่ผลิต ●ญี่ปุ่น

TRUSCO NAKAYAMA CORPORATION				
Order Code	Item No.	Price (per pack)	Q'ty Per Pack (pcs)	Weight (g)
232-7929	P-24SUS	543THB	4	50

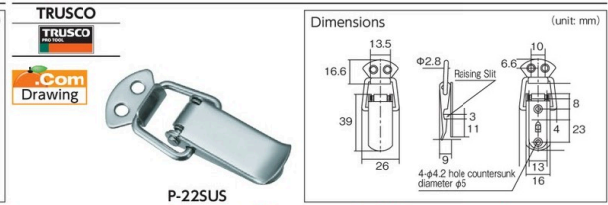

Draw Latch (standard type, stainless steel)

ประเทศที่ผลิต ●ญี่ปุ่น

TRUSCO NAKAYAMA CORPORATION				
Order Code	Item No.	Price (per pack)	Q'ty Per Pack (pcs)	Weight (g)
232-8186	P-22SUS	677THB	4	90

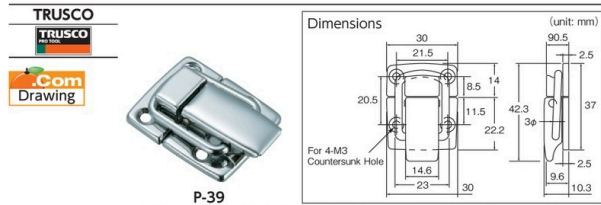

Draw Latch (sideways displacement prevention type, steel)

วัสดุ ●กรรมวิธีอบชุบผิว: ผิวสำเร็จชุบโครเมียมไตรวาเลนท์ ประเทศที่ผลิต ●ญี่ปุ่น

TRUSCO NAKAYAMA CORPORATION				
Order Code	Item No.	Price (per pack)	Q'ty Per Pack (pcs)	Weight (g)
232-8615	P-39	496THB	4	90

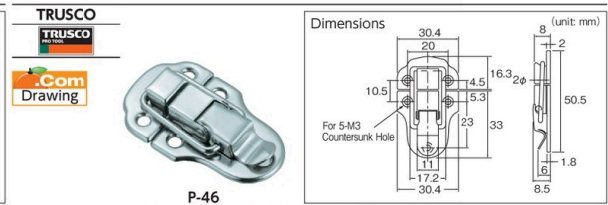

Draw Latch (sideways displacement prevention type, steel)

วัสดุ ●กรรมวิธีอบชุบผิว: ผิวสำเร็จชุบนิเกิล ประเทศที่ผลิต ●ญี่ปุ่น

TRUSCO NAKAYAMA CORPORATION				
Order Code	Item No.	Price (per pack)	Q'ty Per Pack (pcs)	Weight (g)
232-8453	P-46	509THB	4	80

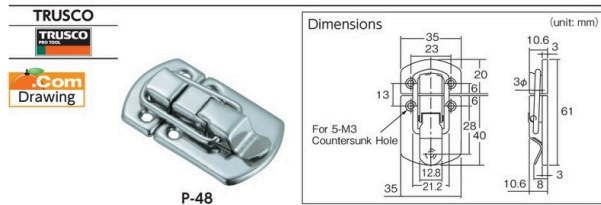

Draw Latch (sideways displacement prevention type, steel)

วัสดุ ●กรรมวิธีอบชุบผิว: ผิวสำเร็จชุบนิเกิล ประเทศที่ผลิต ●ญี่ปุ่น

TRUSCO NAKAYAMA CORPORATION				
Order Code	Item No.	Price (per pack)	Q'ty Per Pack (pcs)	Weight (g)
232-8577	P-48	534THB	4	180



Draw Latch (sideways displacement prevention type, steel)

วัสดุ ●กรรมวิธีอบชุบผิว: ผิวสำเร็จชุบโครเมียมไตรวาเลนท์ ประเทศที่ผลิต ●ญี่ปุ่น

TRUSCO NAKAYAMA CORPORATION				
Order Code	Item No.	Price (per pack)	Q'ty Per Pack (pcs)	Weight (g)
232-9191	P-19	496THB	4	120



Draw Latch (sideways displacement prevention type, steel)

วัสดุ ●กรรมวิธีอบชุบผิว: ผิวสำเร็จชุบโครเมียมไตรวาเลนท์ ประเทศที่ผลิต ●ญี่ปุ่น

TRUSCO NAKAYAMA CORPORATION				
Order Code	Item No.	Price (per pack)	Q'ty Per Pack (pcs)	Weight (g)
232-9247	P-16	302THB	2	120



Draw Latch (sideways displacement prevention type, steel)

วัสดุ ●กรรมวิธีอบชุบผิว: ผิวสำเร็จชุบนิเกิล ประเทศที่ผลิต ●ญี่ปุ่น

TRUSCO NAKAYAMA CORPORATION				
Order Code	Item No.	Price (per pack)	Q'ty Per Pack (pcs)	Weight (g)
232-9271	P-11	317THB	2	110

รหัสสั่งซื้อ **สีน้ำเงิน** ... มีสินค้าสต็อกที่ประเทศอินโดนีเซียและประเทศไทย **สีแดง** ... มีสินค้าสต็อกที่ประเทศอินโดนีเซีย **สีเขียว** ... มีสินค้าสต็อกที่ประเทศไทย

- O-Rings·Oil Seals
- Rubbers
- Resins
- Metal Materials
- Vibration Absorber
- Adjusters
- Plungers
- Springs for Die
- Springs
- Split Pins
- Snap Rings
- Oil Gauges
- Oil Tank Caps
- Knobs
- Lever
- Grip Handles
- Handles
- Hinges
- Slide Rails
- Stays
- Toggle Latches
- Fastening Parts
- Aluminum Frames

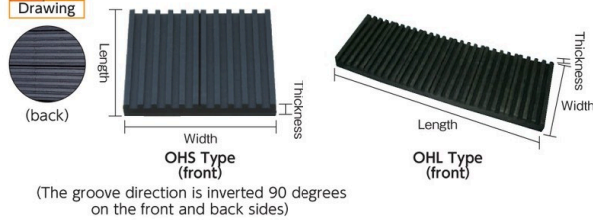
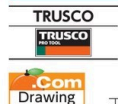

(The groove direction is inverted 90 degrees on the front and back sides)

Vibration Absorbing Pad (natural rubber)

คุณสมบัติ ●ใช้งานง่าย สามารถใช้ติดตั้งไปปากเป็นร่องรูปตัววีโดยเว้นระยะ 50 มม.
 ข้อมูลจำเพาะ ●ความแข็งของยาง: 55±5
 ●ช่วงอุณหภูมิทำงาน: -5 ถึง 70°C
 ●ขนาดใหญ่ที่สุด: 600 x 1000 มม.
 วัสดุ ●ยางธรรมชาติ (NR)
 ประเทศที่ผลิต ●จีน

Mini sheet type

Order Unit: 1 Sheet		TRUSCO NAKAYAMA CORPORATION					
Order Code	Item No.	Price (per sheet)	Allowable Surface Pressure (N/mm ²)	Thickness (mm)	Width (mm)	Length (mm)	Weight (kg)
405-4687	OHS-10-50	23THB	0.5	10	50	50	0.03
405-4695	OHS-10-100	55THB	0.5	10	100	100	0.10
405-4709	OHS-10-150	119THB	0.5	10	150	150	0.30
405-4717	OHS-10-200	172THB	0.5	10	200	200	0.40

Sheet Type

Order Unit: 1 Sheet		TRUSCO NAKAYAMA CORPORATION					
Order Code	Item No.	Price (per sheet)	Allowable Surface Pressure (N/mm ²)	Thickness (mm)	Width (mm)	Length (mm)	Weight (kg)
170-4583	OH-8	305THB	0.5	8	300	300	0.7
170-4605	OH-10	369THB	0.5	10	300	300	0.8
170-4621	OH-20	1,060THB	0.3	20	300	300	1.7

⚠ ข้อควรระวัง
 ●OH-8 ไม่มีร่องรูปตัว V

Belts Type

Order Unit: 1 Sheet		TRUSCO NAKAYAMA CORPORATION						
Order Code	Item No.	Price (per sheet)	Allowable Surface Pressure (N/mm ²)	Thickness (mm)	Width (mm)	Length (mm)	Weight (kg)	
170-4648	OHL-10-100	444THB	0.5	10	100	1000	0.9	
170-4656	OHL-10-150	656THB	0.5	10	150	1000	1.5	
405-4725	OHL-10-300	1,336THB	0.5	10	300	1000	3.0	
272-6971	OHL-10-600	2,141THB	0.5	10	600	1000	5.5	
170-4664	OHL-15-100	597THB	0.4	15	100	1000	1.2	
170-4672	OHL-15-150	874THB	0.4	15	150	1000	2.0	
405-4733	OHL-15-300	1,774THB	0.4	15	300	1000	4.2	
272-6980	OHL-15-600	3,910THB	0.4	15	600	1000	7.0	
272-6998	OHL-20-600	4,771THB	0.3	20	600	1000	11.0	

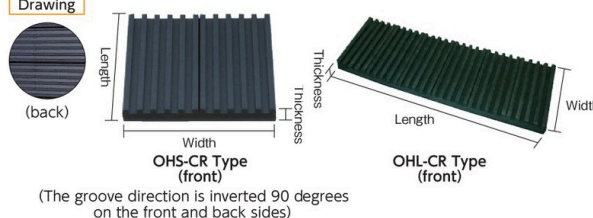

(The groove direction is inverted 90 degrees on the front and back sides)

Vibration Absorbing Pad (synthetic rubber/heat resistant oil type)

คุณสมบัติ ●ใช้งานง่าย สามารถใช้ติดตั้งไปปากเป็นร่องรูปตัววีโดยเว้นระยะ 50 มม.
 ●ทนต่อน้ำมันหล่อลื่น น้ำมันเครื่อง น้ำมันหล่อลื่น และอื่นๆ
 ข้อมูลจำเพาะ ●ความแข็งของยาง: 55±5
 ●ช่วงอุณหภูมิทำงาน: -5 ถึง 110°C
 วัสดุ ●ยางสังเคราะห์ (CR)
 ประเทศที่ผลิต ●จีน

Mini sheet type

Order Unit: 1 Sheet		TRUSCO NAKAYAMA CORPORATION					
Order Code	Item No.	Price (per sheet)	Allowable Surface Pressure (N/mm ²)	Thickness (mm)	Width (mm)	Length (mm)	Weight (kg)
484-3291	OHS-10-50CR	42THB	0.5	10	50	50	0.03
484-3266	OHS-10-100CR	109THB	0.5	10	100	100	0.10
484-3274	OHS-10-150CR	206THB	0.5	10	150	150	0.30
484-3282	OHS-10-200CR	302THB	0.5	10	200	200	0.40

Sheet Type

Order Unit: 1 Sheet		TRUSCO NAKAYAMA CORPORATION					
Order Code	Item No.	Price (per sheet)	Allowable Surface Pressure (N/mm ²)	Thickness (mm)	Width (mm)	Length (mm)	Weight (kg)
170-4591	OH-8CR	584THB	0.5	8	300	300	0.7
170-4613	OH-10CR	721THB	0.5	10	300	300	0.8
170-4630	OH-20CR	1,959THB	0.3	20	300	300	1.7

⚠ ข้อควรระวัง
 ●OH-8CR ไม่มีร่องรูปตัว V

Belts Type

Order Unit: 1 Sheet		TRUSCO NAKAYAMA CORPORATION						
Order Code	Item No.	Price (per sheet)	Allowable Surface Pressure (N/mm ²)	Thickness (mm)	Width (mm)	Length (mm)	Weight (kg)	
484-3177	OHL-10-100CR	876THB	0.5	10	100	1000	0.9	
484-3185	OHL-10-150CR	1,240THB	0.5	10	150	1000	1.5	
484-3193	OHL-10-300CR	3,024THB	0.5	10	300	1000	3.1	
484-3207	OHL-10-600CR	5,441THB	0.5	10	600	1000	5.6	
484-3215	OHL-15-100CR	1,087THB	0.4	15	100	1000	1.2	
484-3223	OHL-15-150CR	1,633THB	0.4	15	150	1000	2.1	
484-3231	OHL-15-300CR	5,231THB	0.4	15	300	1000	4.3	
484-3240	OHL-15-600CR	10,340THB	0.4	15	600	1000	7.2	
484-3258	OHL-20-600CR	11,971THB	0.3	20	600	1000	11.3	



TP Type

Urethane Cushion Seal

คุณสมบัติ ●ใช้โฟลียูรีเทนที่ไม่เป็นสีเหลือง ที่มีความยืดหยุ่นสูงมากและดูดซับแรงสะท้อนได้ดี
 ●มีความทนทานสูงและต้านแรงสั่นสะเทือนได้ดี
 ●แบบปิดผนึกเกาะติดง่าย
 ข้อมูลจำเพาะ ●ความแข็ง: Asker C80
 วัสดุ ●โฟลียูรีเทน
 ประเทศที่ผลิต ●ญี่ปุ่น

Order Unit: 1 Sheet		TRUSCO NAKAYAMA CORPORATION					
Order Code	Item No.	Price (per sheet)	Color	Shape	Diameter x H (mm)	Q'ty Per Sheet (pcs)	Weight (g)
764-5058	TP6R-90	277THB	Transparent	Round Shape	6 x 2	90	5.2
764-5066	TP8R-70	216THB	Transparent	Round Shape	8 x 2	70	6.9
764-4990	TP10R-60	209THB	Transparent	Round Shape	10 x 2	60	9.1
764-5007	TP12R-60	277THB	Transparent	Round Shape	12 x 2	60	12.6
764-5015	TP14R-50	270THB	Transparent	Round Shape	14 x 2	50	16.0
764-5023	TP16R-50	305THB	Transparent	Round Shape	16 x 2	50	21.7
764-5031	TP20R-24	178THB	Transparent	Round Shape	20 x 2	24	15.2
764-5040	TP30R-8	92THB	Transparent	Round Shape	30 x 2	8	13.6

รหัสสั่งซื้อ **สีน้ำเงิน** ... มีสินค้าสต็อกที่ประเทศอินโดนีเซียและประเทศไทย **สีแดง** ... มีสินค้าสต็อกที่ประเทศอินโดนีเซีย **สีเขียว** ... มีสินค้าสต็อกที่ประเทศไทย

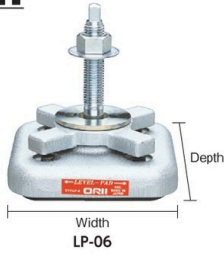

Vibration Absorbing Device "Level Pad"

คุณสมบัติ ●ยางลดแรงสั่นสะเทือนถูกแบ่งออกเป็น 4 ส่วน
จึงลดแรงสั่นสะเทือนได้อย่างมีประสิทธิภาพ
วัสดุ ●มีฟังก์ชันการปรับระดับและยังตอบสนองต่อการเอียงด้วย
●กรอบ: FC250
●แฉัก: FC300
●ยางดูดซับแรงสั่นสะเทือน: NBR
●โพลทีดีดตั้ง: SS400
ประเทศที่ผลิต ●ญี่ปุ่น

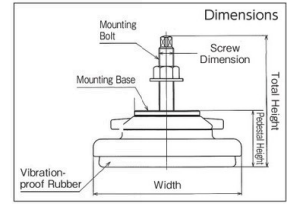

Order Unit: 1 Pcs

Order Code	Item No.	Price (per pcs)	Allowable Weight (kg)	Width (mm)	Depth (mm)	Pedestal Height (mm)	Screw Dimension	Total Height (mm)	Level Adjustment Amount (mm)	Weight (kg)
485-4501	LP-03	1,951THB	300	110	110	49	M12 x 1.75	129	15	1.47
485-4519	LP-06	2,636THB	600	130	130	51	M16 x 2.00	135	15	2.32
104-1312	LP-12	5,800THB	1200	180	180	68	M18 x 2.50	158	26	5.22
104-1321	LP-18	7,381THB	1800	220	220	75	M20 x 2.50	165	25	8.66

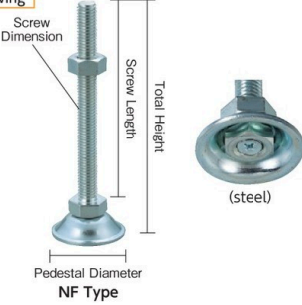
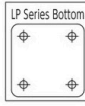

Adjuster Bolt (400kgf type)

วัสดุ ●สกรู: เหล็กกล้า
●แผ่นที่ฐาน: เหล็กกล้า
ประเทศที่ผลิต ●จีน

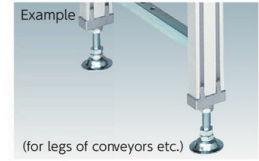

Order Unit: 1 Pcs

Order Code	Item No.	Price (per pcs)	Allowable Weight (kgf)	Screw Dimension	Screw Length (mm)	Total Height (mm)	Pedestal Diameter (mm)	Weight (g)
233-2655	NF8X50	96THB	400	M8 x 1.25	50	66.0	37	50
233-2663	NF8X100	116THB	400	M8 x 1.25	100	116.0	37	65
233-2671	NF10X50	120THB	400	M10 x 1.50	50	67.5	37	75
233-2680	NF10X100	128THB	400	M10 x 1.50	100	117.5	37	100

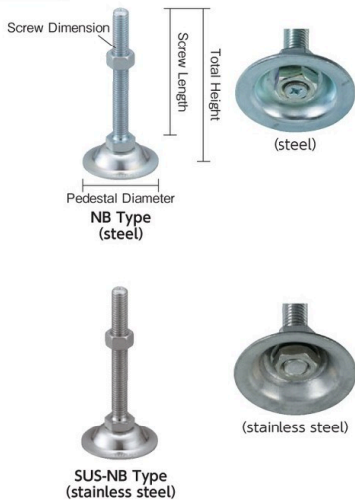

Adjuster Bolt (500/600kgf type)

ประเทศที่ผลิต ●จีน

Steel

Order Unit: 1 Pcs

Order Code	Item No.	Price (per pcs)	Allowable Weight (kgf)	Screw Dimension	Screw Length (mm)	Total Height (mm)	Pedestal Diameter (mm)	Weight (g)
231-4240	NB12X100	119THB	500	M12 x 1.75	100	121.5	55	172
231-4258	NB12X120	123THB	500	M12 x 1.75	120	141.5	55	190
231-4568	NB12X150	168THB	500	M12 x 1.75	150	171.5	55	205
231-4002	NA16X100	182THB	500	M16 x 2.00	100	128.5	75	333
231-4011	NA16X130	209THB	500	M16 x 2.00	130	158.5	75	372
231-4452	NA16X150	222THB	500	M16 x 2.00	150	178.5	75	390
231-4029	NA16X180	239THB	500	M16 x 2.00	180	208.5	75	441
231-4037	NA20X100	250THB	500	M20 x 2.50	100	131.5	75	493
231-4045	NA20X130	275THB	500	M20 x 2.50	130	161.5	75	561
231-4461	NA20X150	329THB	500	M20 x 2.50	150	181.5	75	600
231-4053	NA20X180	336THB	500	M20 x 2.50	180	211.5	75	672

Stainless Steel

Order Unit: 1 Pcs

Order Code	Item No.	Price (per pcs)	Allowable Weight (kgf)	Screw Dimension	Screw Length (mm)	Total Height (mm)	Pedestal Diameter (mm)	Weight (g)
231-4282	SUS-NB12X100	389THB	600	M12 x 1.75	100	121.5	55	165
231-4291	SUS-NB12X120	414THB	600	M12 x 1.75	120	141.5	55	185
231-4541	SUS-NB12X150	454THB	600	M12 x 1.75	150	171.5	55	210
231-4126	SUS-NA16X100	697THB	600	M16 x 2.00	100	128.5	75	299
231-4134	SUS-NA16X130	773THB	600	M16 x 2.00	130	158.5	75	357
231-4495	SUS-NA16X150	820THB	600	M16 x 2.00	150	178.5	75	380
231-4142	SUS-NA16X180	891THB	600	M16 x 2.00	180	208.5	75	422
231-4151	SUS-NA20X100	1,009THB	600	M20 x 2.50	100	131.5	75	496
231-4169	SUS-NA20X130	1,171THB	600	M20 x 2.50	130	161.5	75	549
231-4509	SUS-NA20X150	1,294THB	600	M20 x 2.50	150	181.5	75	585
231-4177	SUS-NA20X180	1,411THB	600	M20 x 2.50	180	211.5	75	655

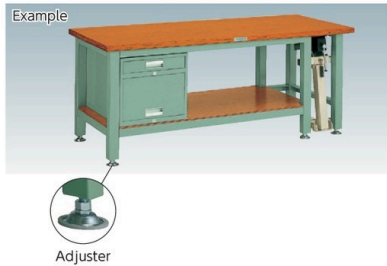

รหัสสั่งซื้อ **สีน้ำเงิน** ... มีสินค้าสต็อกที่ประเทศอินโดนีเซียและประเทศไทย **สีแดง** ... มีสินค้าสต็อกที่ประเทศอินโดนีเซีย **สีเขียว** ... มีสินค้าสต็อกที่ประเทศไทย

365 Machine Parts

- O-Rings
- Oil Seals
- Rubbers
- Resins
- Metal Materials
- Vibration Absorber
- Adjusters

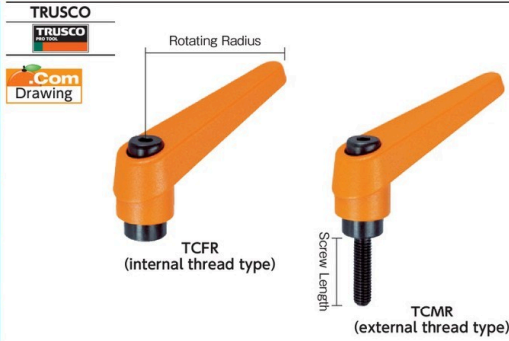

Adjustable Handle

คุณสมบัติ ● คันโยกที่ตั้งตำแหน่งได้
วัสดุ ● สกรู: เหล็กกล้า
● คันโยก: สังกะสีหล่อชุบ
ประเทศที่ผลิต ● เยอรมนี

Internal Thread Type

Order Unit: 1 Pcs		TRUSCO NAKAYAMA CORPORATION				
Order Code	Item No.	Price (per pcs)	Screw Dimension	Screw Height (mm)	Rotating Radius (mm)	Weight (g)
798-2895	TCFR-5	393THB	M5 x 0.80	8	45	33
798-2909	TCFR-6	393THB	M6 x 1.00	8	45	33
798-2917	TCFR-8	484THB	M8 x 1.25	10	62	67
798-2861	TCFR-10	544THB	M10 x 1.50	14	74	109
798-2879	TCFR-12	604THB	M12 x 1.75	17	89	171
798-2887	TCFR-16	726THB	M16 x 2.00	22	108	269

External Thread Type

Order Unit: 1 Pcs						
Order Code	Item No.	Price (per pcs)	Screw Dimension	Screw Length (mm)	Rotating Radius (mm)	Weight (g)
798-3069	TCMR5-12	434THB	M5 x 0.80	12	45	36
798-3077	TCMR5-16	434THB	M5 x 0.80	16	45	36
798-3085	TCMR5-20	434THB	M5 x 0.80	20	45	37
798-3093	TCMR5-25	434THB	M5 x 0.80	25	45	38
798-3107	TCMR5-32	434THB	M5 x 0.80	32	45	38
798-3115	TCMR6-12	434THB	M6 x 1.00	12	45	37
798-3123	TCMR6-16	434THB	M6 x 1.00	16	45	37
798-3131	TCMR6-20	434THB	M6 x 1.00	20	45	38
798-3140	TCMR6-25	434THB	M6 x 1.00	25	45	39
798-3158	TCMR6-32	434THB	M6 x 1.00	32	45	40
798-3166	TCMR8-16	544THB	M8 x 1.25	16	62	74
798-3174	TCMR8-20	544THB	M8 x 1.25	20	62	76
798-3182	TCMR8-25	544THB	M8 x 1.25	25	62	77
798-3191	TCMR8-32	544THB	M8 x 1.25	32	62	79
798-3204	TCMR8-40	580THB	M8 x 1.25	40	62	81

Order Unit: 1 Pcs						
Order Code	Item No.	Price (per pcs)	Screw Dimension	Screw Length (mm)	Rotating Radius (mm)	Weight (g)
798-2925	TCMR10-20	580THB	M10 x 1.50	20	74	128
798-2933	TCMR10-25	580THB	M10 x 1.50	25	74	130
798-2941	TCMR10-32	580THB	M10 x 1.50	32	74	134
798-2950	TCMR10-40	653THB	M10 x 1.50	40	74	138
798-2968	TCMR10-50	653THB	M10 x 1.50	50	74	143
798-2976	TCMR12-25	653THB	M12 x 1.75	25	89	205
798-2984	TCMR12-32	653THB	M12 x 1.75	32	89	209
798-2992	TCMR12-40	690THB	M12 x 1.75	40	89	215
798-3000	TCMR12-50	690THB	M12 x 1.75	50	89	222
798-3018	TCMR12-63	690THB	M12 x 1.75	63	89	232
798-3026	TCMR16-32	797THB	M16 x 2.00	32	108	348
798-3034	TCMR16-40	871THB	M16 x 2.00	40	108	357
798-3042	TCMR16-50	871THB	M16 x 2.00	50	108	370
798-3051	TCMR16-63	871THB	M16 x 2.00	63	108	386

- Plungers
- Springs for Die
- Springs
- Split Pins
- Snap Rings
- Oil Gauges

- Oil Tank Caps
- Knobs
- Lever
- Grip Handles
- Handles
- Hinges

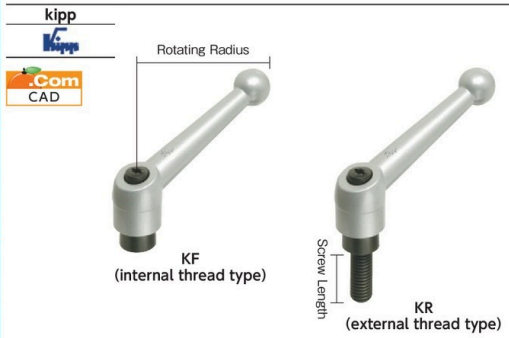

Adjustable Handle

คุณสมบัติ ● คันโยกที่ใช้ได้ทั่วไปสำหรับการติดตั้งตำแหน่งที่จับ
วัสดุ ● สกรู: เหล็กกล้า
● คันโยก: สังกะสีหล่อชุบ
ประเทศที่ผลิต ● เยอรมนี

Internal Thread Type

Order Unit: 1 Pcs						
Order Code	Item No.	Price (per pcs)	Screw Dimension	Screw Height (mm)	Rotating Radius (mm)	Weight (g)
107-9212	KF5	553THB	M5 x 0.80	9	40	30
107-9221	KF6	553THB	M6 x 1.00	9	40	30
107-9239	KF8	701THB	M8 x 1.25	12	65	80
107-9247	KF10	751THB	M10 x 1.50	14	80	120
107-9255	KF12	851THB	M12 x 1.75	17	95	190
107-9263	KF16	1,001THB	M16 x 2.00	23	110	300

External Thread Type

Order Unit: 1 Pcs						
Order Code	Item No.	Price (per pcs)	Screw Dimension	Screw Length (mm)	Rotating Radius (mm)	Weight (g)
107-9271	KR5X10	601THB	M5 x 0.80	10	40	30
107-9280	KR5X15	601THB	M5 x 0.80	15	40	31
107-9298	KR5X20	601THB	M5 x 0.80	20	40	33
107-9301	KR5X25	601THB	M5 x 0.80	25	40	34
107-9310	KR5X30	601THB	M5 x 0.80	30	40	35
107-9328	KR6X10	601THB	M6 x 1.00	10	40	30
107-9336	KR6X15	601THB	M6 x 1.00	15	40	31
107-9344	KR6X20	601THB	M6 x 1.00	20	40	33
107-9352	KR6X25	601THB	M6 x 1.00	25	40	34
107-9361	KR6X30	601THB	M6 x 1.00	30	40	35
107-9387	KR8X15	751THB	M8 x 1.25	15	65	80
107-9395	KR8X20	751THB	M8 x 1.25	20	65	81
107-9409	KR8X25	751THB	M8 x 1.25	25	65	82
107-9417	KR8X30	751THB	M8 x 1.25	30	65	83
110-7569	KR8X40	803THB	M8 x 1.25	40	65	85

Order Unit: 1 Pcs						
Order Code	Item No.	Price (per pcs)	Screw Dimension	Screw Length (mm)	Rotating Radius (mm)	Weight (g)
107-9425	KR10X20	803THB	M10 x 1.50	20	80	130
107-9433	KR10X25	803THB	M10 x 1.50	25	80	133
107-9441	KR10X30	803THB	M10 x 1.50	30	80	140
107-9450	KR10X40	900THB	M10 x 1.50	40	80	145
107-9468	KR10X50	900THB	M10 x 1.50	50	80	150
107-9476	KR12X25	900THB	M12 x 1.75	25	95	215
107-9484	KR12X30	900THB	M12 x 1.75	30	95	220
107-9492	KR12X40	953THB	M12 x 1.75	40	95	225
107-9506	KR12X50	953THB	M12 x 1.75	50	95	230
107-9514	KR12X60	953THB	M12 x 1.75	60	95	240
107-9522	KR16X30	1,101THB	M16 x 2.00	30	110	360
107-9531	KR16X40	1,203THB	M16 x 2.00	40	110	375
107-9549	KR16X50	1,203THB	M16 x 2.00	50	110	390
107-9557	KR16X60	1,203THB	M16 x 2.00	60	110	400

- Stays
- Toggle Latches
- Fastening Parts
- Aluminum Frames

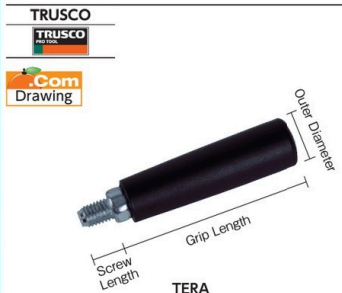

Engineering Plastic Rotating Handle

ข้อมูลจำเพาะ ● อุณหภูมิต้านทานความร้อน: 180°C
วัสดุ ● ด้ามจับ: โพลีเอไมด์ (PA)
● สกรู: เหล็กกล้า
ประเทศที่ผลิต ● จีน

Order Unit: 1 Pcs							
Order Code	Item No.	Price (per pcs)	Outer Diameter (mm)	Grip Length (mm)	Screw Dimension	Screw Length (mm)	Weight (g)
836-8113	TERA-2150	143THB	21	50	M6 x 1.00	13	55
836-8114	TERA-2365	188THB	23	65	M8 x 1.25	15	80
836-8115	TERA-2680	270THB	26	80	M10 x 1.50	16	105

365

สินค้าบางรายการไม่สามารถนำเข้าได้ สินค้าบางรายการไม่สามารถใช้กับไฟฟ้ไทยได้ ราคาไม่รวมภาษีมูลค่าเพิ่ม

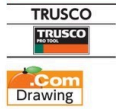

TTO-B Type (external thread type)

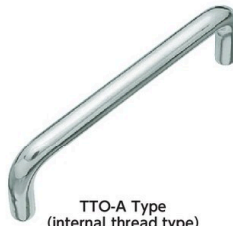
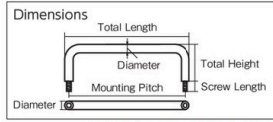

TTO-A Type (internal thread type)

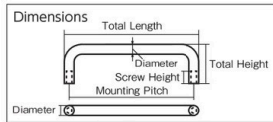

TTO-W Type (decoration washer)

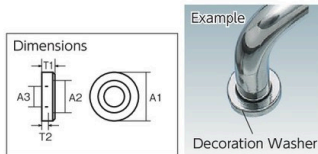

Pull Handle (stainless steel, mirror finish)

คุณสมบัติ • ตามจับขัดเงาที่มีเนื้อวัสดุสวยงามซึ่งทำจากเหล็กกล้าไร้สนิม
วัสดุ • เหล็กกล้าไร้สนิม (SUS304)
ประเทศที่ผลิต • จีน

External Thread Type อุปกรณ์เสริม • น๊อตทรงสปริง/น๊อตหกเหลี่ยมอย่างละ 2 ชิ้น

TRUSCO NAKAYAMA CORPORATION										
Order Code	Item No.	Price (per pcs)	Total Length (mm)	Total Height (mm)	Diameter (mm)	Screw Dimension	Screw Length (mm)	Mounting Pitch (mm)	Reference Working Load (kN)	Weight (g)
275-4495	TTO-6-40B	103THB	46	23	6	M4 x 0.70	7	40	0.20	19
275-4509	TTO-6-60B	109THB	66	23	6	M4 x 0.70	7	60	0.20	23
275-4517	TTO-6-80B	119THB	86	30	6	M4 x 0.70	7	80	0.20	30
284-8121	TTO-7-68B	116THB	75	30	7	M5 x 0.80	11	68	0.44	39
275-4525	TTO-8-90B	155THB	98	30	8	M5 x 0.80	11	90	0.44	57
275-4533	TTO-8-100B	165THB	108	40	8	M5 x 0.80	11	100	0.44	68
275-4541	TTO-8-110B	169THB	118	40	8	M5 x 0.80	11	110	0.44	72
275-4550	TTO-8-120B	172THB	128	40	8	M5 x 0.80	11	120	0.44	76
284-8139	TTO-9-100B	172THB	109	30	9	M5 x 0.80	11	100	0.44	75
275-4568	TTO-10-100B	223THB	110	50	10	M6 x 1.00	11	100	0.59	119
275-4576	TTO-10-110B	233THB	120	50	10	M6 x 1.00	11	110	0.59	124
275-4584	TTO-10-120B	250THB	130	50	10	M6 x 1.00	11	120	0.59	132
275-4592	TTO-12-150B	383THB	162	50	12	M8 x 1.25	20	150	0.74	218
275-4606	TTO-12-200B	456THB	212	50	12	M8 x 1.25	20	200	0.74	262
275-4614	TTO-12-250B	493THB	262	50	12	M8 x 1.25	20	250	0.74	305
275-4622	TTO-12-300B	544THB	312	50	12	M8 x 1.25	20	300	0.74	350

Internal Thread Type

TRUSCO NAKAYAMA CORPORATION										
Order Code	Item No.	Price (per pcs)	Total Length (mm)	Total Height (mm)	Diameter (mm)	Screw Dimension	Screw Height (mm)	Mounting Pitch (mm)	Reference Working Load (kN)	Weight (g)
275-4355	TTO-6-40A	89THB	46	23	6	M4 x 0.70	7.0	40	0.20	14
275-4363	TTO-6-60A	96THB	66	23	6	M4 x 0.70	7.0	60	0.20	18
275-4371	TTO-6-80A	116THB	86	30	6	M4 x 0.70	7.0	80	0.20	26
284-8147	TTO-7-68A	119THB	75	30	7	M5 x 0.80	8.0	68	0.44	30
275-4380	TTO-8-90A	148THB	98	30	8	M5 x 0.80	8.0	90	0.44	48
275-4398	TTO-8-100A	155THB	108	40	8	M5 x 0.80	8.0	100	0.44	61
275-4401	TTO-8-110A	168THB	118	40	8	M5 x 0.80	8.0	110	0.44	63
275-4410	TTO-8-120A	165THB	128	40	8	M5 x 0.80	8.0	120	0.44	67
284-8155	TTO-9-100A	172THB	109	30	9	M5 x 0.80	8.0	100	0.44	65
275-4428	TTO-10-100A	212THB	110	50	10	M6 x 1.00	8.0	100	0.59	105
275-4436	TTO-10-110A	219THB	120	50	10	M6 x 1.00	8.0	110	0.59	112
275-4444	TTO-10-120A	233THB	130	50	10	M6 x 1.00	8.0	120	0.59	118
275-4452	TTO-12-150A	383THB	162	50	12	M8 x 1.25	12.5	150	0.74	181
275-4461	TTO-12-200A	434THB	212	50	12	M8 x 1.25	12.5	200	0.74	226
275-4479	TTO-12-250A	473THB	262	50	12	M8 x 1.25	12.5	250	0.74	269
275-4487	TTO-12-300A	520THB	312	50	12	M8 x 1.25	12.5	300	0.74	314

Decoration Washer

Order Code	Item No.	Price (per pack)	A1 (mm)	A2 (mm)	A3 (mm)	T1 (mm)	T2 (mm)	Applicable Pull Handle	Qty Per Pack (pcs)	Weight (g)
275-4631	TTO-6W	49THB	10	6.2	4.3	2.5	1.5	TTO- 6 Series	2	2.2
284-8104	TTO-7W	49THB	11	7.2	5.1	2.5	1.5	TTO- 7 Series	2	2.4
275-4649	TTO-8W	56THB	13	8.2	5.0	3.0	1.0	TTO- 8 Series	2	4.0
284-8112	TTO-9W	56THB	13	9.2	5.2	3.0	1.0	TTO- 9 Series	2	3.4
275-4657	TTO-10W	73THB	15	10.2	6.0	3.5	1.5	TTO-10 Series	2	6.0
275-4665	TTO-12W	95THB	18	12.2	8.3	4.6	1.6	TTO-12 Series	2	11.0

Pull Handle Inclined Type (stainless steel, mirror finish)

คุณสมบัติ • ตามจับขัดเงาที่มีเนื้อวัสดุสวยงามซึ่งทำจากเหล็กกล้าไร้สนิม
วัสดุ • เหล็กกล้าไร้สนิม (SUS304)
ประเทศที่ผลิต • จีน

External Thread Type

TRUSCO NAKAYAMA CORPORATION										
Order Code	Item No.	Price (per pcs)	Total Length (mm)	Total Height (mm)	Diameter (mm)	Screw Dimension	Screw Length (mm)	Mounting Pitch (mm)	Reference Working Load (kN)	Weight (g)
469-4121	TTA-9-100B	290THB	109	85	9	M6 x 1	17	100	130	

Internal Thread Type ข้อมูลจำเพาะ • เกสซีวี่น

Order Code	Item No.	Price (per pcs)	Total Length (mm)	Total Height (mm)	Diameter (mm)	Screw Dimension	Screw Height (mm)	Mounting Pitch (mm)	Reference Working Load (kN)	Weight (g)
469-4082	TTA-6-60A	148THB	66	30.0	6	M4 x 0.7	7	60	0.39	23
469-4091	TTA-6-80A	158THB	86	31.5	6	M4 x 0.7	7	80	0.39	28
469-4104	TTA-8-100A	172THB	108	32.0	8	M5 x 0.8	10	100	0.49	54
469-4112	TTA-8-120A	185THB	128	40.0	8	M5 x 0.8	10	120	0.49	70

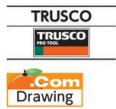

TTA-9-100B (external thread type)



TTA-8-100A (internal thread type)

รหัสสั่งซื้อ **สีน้ำเงิน** ... มีสินค้าสต็อกที่ประเทศอินโดนีเซียและประเทศไทย **สีแดง** ... มีสินค้าสต็อกที่ประเทศอินโดนีเซีย **สีเขียว** ... มีสินค้าสต็อกที่ประเทศไทย

- O-Rings·Oil Seals
- Rubbers
- Resins
- Metal Materials
- Vibration Absorber
- Adjusters
- Plungers
- Springs for Die
- Springs
- Split Pins
- Snap Rings
- Oil Gauges
- Oil Tank Caps
- Knobs
- Levers
- Grip Handles
- Handles
- Hinges
- Slide Rails
- Stays
- Toggle Latches
- Fastening Parts
- Aluminum Frames

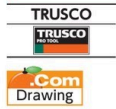

TKH-100CA

Total Length	P1	P2	P3	Wood Screw Size (D x L)
25	20	13	-	3 x 20
30	20	16	-	3 x 20
40	20	24	-	3 x 20
50	20	30	-	3 x 20
60	20	44	22	3 x 20
65	20	48	24	3 x 20
75	20	56	28	3 x 20
80	20	60	30	3 x 20
90	20	70	35	3 x 20
100	20	78	26	3 x 20

Hinge (stainless steel SUS304)

ข้อมูลจำเพาะ •กรรมวิธีอบชุบผิว: ผิวสำเร็จแบบ Buffed mirror
•วิธีการติดตั้ง: สกรูไม้ (ขายแยก)

ประเทศที่ผลิต •จีน

Order Unit: 1 Pcs

Order Code	Item No.	Price (per pcs)	Total Length (mm)	Width (mm)	Thickness (mm)	D2 (mm)	Threaded Hole Number	Hole Diameter (mm)	Load Capacity (kg) when 2 pieces used	Weight (g)
279-6082	TKH-25CA	119THB	25	32	1.5	6.3	4	3.2	3	13
279-6091	TKH-30CA	128THB	30	32	1.5	6.3	4	3.2	4	16
279-6104	TKH-40CA	123THB	40	32	1.5	6.3	4	3.2	6	21
279-6112	TKH-50CA	133THB	50	32	1.5	6.3	4	3.2	7	26
279-6121	TKH-60CA	155THB	60	32	1.5	6.3	6	3.2	9	31
279-6139	TKH-65CA	172THB	65	32	1.5	6.3	6	3.2	10	34
279-6147	TKH-75CA	198THB	75	32	1.5	6.3	6	3.2	11	39
279-6155	TKH-80CA	202THB	80	32	1.5	6.3	6	3.2	12	42
279-6163	TKH-90CA	219THB	90	32	1.5	6.3	6	3.2	13	47
279-6171	TKH-100CA	222THB	100	32	1.5	6.3	8	3.2	15	52

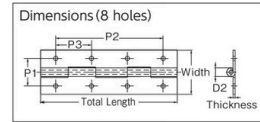

RoHS

O-Rings· Oil Seals

Rubbers

Resins

Metal Materials

Vibration Absorber

Adjusters

Plungers

Spring for Die

Spring

Split Pins

Snap Rings

Oil Gauges

Oil Tank Caps

Knobs

Lever

Grip Handles

Handles

Hinges

Slide Rails

Stays

Toggle Latches

Fastening Parts

Aluminum Frames

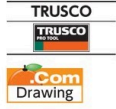

TLS-90B

Total Length	P1	P2	P3	Wood Screw Size (D x L)
40	22	26	-	3 x 16
50	22	34	-	4 x 16
65	30	46	23	4 x 16
75	30	54	27	5 x 20
90	38	70	35	6 x 20
100	38	78	26	6 x 20

Flat Hinge (stainless steel SUS304)

ข้อมูลจำเพาะ •กรรมวิธีอบชุบผิว: ผิวสำเร็จแบบ Buffed mirror
•วิธีการติดตั้ง: สกรูไม้ (ขายแยก)

ประเทศที่ผลิต •จีน

Order Unit: 1 Pcs

Order Code	Item No.	Price (per pcs)	Total Length (mm)	Width (mm)	Thickness (mm)	D2 (mm)	Threaded Hole Number	Hole Diameter (mm)	Load Capacity (kg) when 2 pieces used	Weight (g)
279-5884	TLS-40B	123THB	40	35	1.5	6.3	4	3.2	6	25
279-5892	TLS-50B	145THB	50	35	1.5	6.3	4	4.3	8	30
279-5906	TLS-65B	236THB	65	50	2.0	8.8	6	4.3	13	64
279-5914	TLS-75B	267THB	75	50	2.0	8.8	6	5.3	15	74
279-5922	TLS-90B	469THB	90	60	3.0	12.3	6	6.4	25	180
279-5931	TLS-100B	523THB	100	60	3.0	12.3	8	6.4	30	190

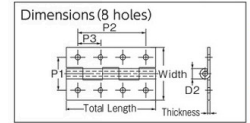

RoHS

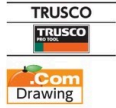

TLS-100F

Total Length	P1	P2	P3	Wood Screw Size (D x L)
50	35	20	-	4 x 16
65	40	35	-	5 x 20
75	50	40	-	6 x 20
100	60	60	30	6 x 20

Heavy Duty Flat Hinge (stainless steel SUS316)

ข้อมูลจำเพาะ •กรรมวิธีอบชุบผิว: ผิวสำเร็จแบบ Buffed mirror
•วิธีการติดตั้ง: สกรูไม้ (ขายแยก)

ประเทศที่ผลิต •จีน

Order Unit: 1 Pcs

Order Code	Item No.	Price (per pcs)	Total Length (mm)	Width (mm)	Thickness (mm)	D2 (mm)	Threaded Hole Number	Hole Diameter (mm)	Load Capacity (kg) when 2 pieces used	Weight (g)
279-6007	TLS-50F	1,186THB	50	50	5	14	4	4	35	110
279-6015	TLS-65F	1,497THB	65	65	5	14	4	5	45	190
279-6023	TLS-75F	1,736THB	75	75	6	16	4	6	65	305
279-6031	TLS-100F	2,040THB	100	100	6	18	6	6	85	500

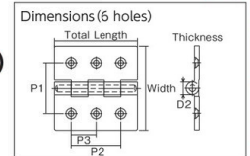

RoHS

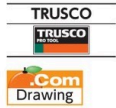

TSH-51C

Total Length	P1	P2	Wood Screw Size (D x L)
25	20	14	3 x 20
38	20	26	3 x 20
51	25	32	3 x 20

Spring Hinge (stainless steel SUS304)

ข้อมูลจำเพาะ •กรรมวิธีอบชุบผิว: ผิวสำเร็จแบบ Buffed mirror
•วิธีการติดตั้ง: สกรูไม้ (ขายแยก)

ประเทศที่ผลิต •จีน

Order Unit: 1 Pcs

Order Code	Item No.	Price (per pcs)	Total Length (mm)	Width (mm)	Thickness (mm)	D2 (mm)	Threaded Hole Number	Hole Diameter (mm)	Load Capacity (kg) when 2 pieces used	Weight (g)
279-6058	TSH-25C	95THB	25	32	1.2	5.8	4	3.2	2	10
279-6066	TSH-38C	123THB	38	32	1.5	6.5	4	3.2	4	20
279-6074	TSH-51C	152THB	51	38	1.5	6.5	4	3.2	6	35

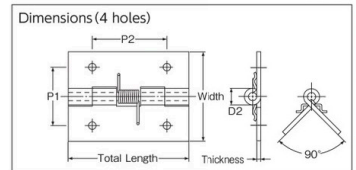

RoHS

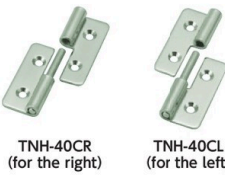
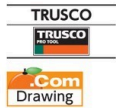

TNH-40CR (for the right)

TNH-40CL (for the left)

P1	P2	Wood Screw Size (D x L)
16	20	3 x 20

Removable Pin Hinge (stainless steel SUS304)

ข้อมูลจำเพาะ •กรรมวิธีอบชุบผิว: ผิวสำเร็จขัดเงา
•วิธีการติดตั้ง: สกรูไม้ (ขายแยก)

ประเทศที่ผลิต •จีน

Order Unit: 1 Set

Order Code	Item No.	Price (per set)	Total Length (mm)	Width (mm)	Thickness (mm)	D2 (mm)	Threaded Hole Number	Hole Diameter (mm)	Load Capacity (kg) when 2 pieces used	Weight (g)
279-6295	TNH-40CR	192THB	40	30	1.5	7	4	3.2	7	21
279-6287	TNH-40CL	192THB	40	30	1.5	7	4	3.2	7	21

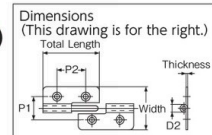

RoHS

รหัสสั่งซื้อ **สีน้ำเงิน** ... มีสินค้าสต็อกที่ประเทศอินโดนีเซียและประเทศไทย **สีแดง** ... มีสินค้าสต็อกที่ประเทศอินโดนีเซีย **สีเขียว** ... มีสินค้าสต็อกที่ประเทศไทย

KYOWA



"Air Breather"
KRM-AB-F Type (with resin filter)

ข้อมูลจำเพาะ ●อุณหภูมิต้านทานความร้อน: 100°C
วัสดุ ●ล้าตัว: โพลีเอไมด์ (PA)
●โอริง: ยางไนไตรล์ (NBR)
ประเทศที่ผลิต ●ญี่ปุ่น

Order Unit: 1 Pcs

Kyowa Corporation.

Order Code	Item No.	Price (per pcs)	Outer Diameter (mm)	Thickness (mm)	Screw Dimension	Screw Length (mm)	Weight (g)
408-2931	KRM-AB1-F	317THB	32	29	G3/8	12	11
408-2982	KRM-AB2-F	332THB	32	30	G1/2	13	12
408-3032	KRM-AB3-F	383THB	42	32	G3/4	13	20
408-3083	KRM-AB4-F	433THB	42	37	G1	18	24

ELESA



"Breather Cap"
BM Type

ข้อมูลจำเพาะ ●อุณหภูมิต้านทานความร้อน: 120°C
วัสดุ ●ฝา: โพลีเอไมด์ (PA) ●ปะเก็น: ยางไนไตรล์ (NBR)
ประเทศที่ผลิต ●อิตาลี

Order Unit: 1 Pcs

IMAQ CORPORATION

Order Code	Item No.	Price (per pcs)	Outer Diameter (mm)	Thickness (mm)	Screw Dimension	Screw Length (mm)	Weight (g)
360-1544	BM-1/4	312THB	31	29.5	G1/4	9.5	11
360-1579	BM-3/8	342THB	31	29.5	G3/8	9.5	13
360-1536	BM-1/2	376THB	31	29.5	G1/2	9.5	15
360-1561	BM-3/4	437THB	42	36.5	G3/4	11.5	28
360-1501	BM-1	496THB	42	36.5	G1	11.5	24
360-1528	BM-1.1/4	687THB	57	44.0	G1 1/4	16.0	50
360-1510	BM-1.1/2	736THB	57	44.0	G1 1/2	16.0	54

TRUSCO



Gripping Ball (plastic)
TPB-BK TPB-R

ข้อมูลจำเพาะ ●แบบไม่มีแกน
วัสดุ ●เรซิน ABS
ประเทศที่ผลิต ●ญี่ปุ่น

Order Unit: 1 Box

TRUSCO NAKAYAMA CORPORATION

Order Code	Item No.	Price (per box)	Outer Diameter (mm)	Screw Dimension	Screw Height (mm)	Qty Per Box (pcs)	Weight (g)
329-2053	TPB20-5BK	1,004THB	20	M5 x 0.80	10	20	100
329-2061	TPB20-6BK	1,004THB	20	M6 x 1.00	10	20	100
329-2070	TPB25-6BK	1,104THB	25	M6 x 1.00	14	20	200
329-2088	TPB25-8BK	1,104THB	25	M8 x 1.25	14	20	200
329-2096	TPB32-8BK	1,531THB	32	M8 x 1.25	14	20	400
329-2100	TPB32-10BK	1,531THB	32	M10 x 1.50	20	20	400
329-2118	TPB40-10BK	2,393THB	40	M10 x 1.50	20	20	800
329-2126	TPB40-12BK	2,393THB	40	M12 x 1.75	20	20	800

TRUSCO



Gripping Ball (plastic)
TPB-5R TPB-6R

ข้อมูลจำเพาะ ●แบบไม่มีแกน
วัสดุ ●เรซิน ABS
ประเทศที่ผลิต ●ญี่ปุ่น

Order Unit: 1 Box

TRUSCO NAKAYAMA CORPORATION

Order Code	Item No.	Price (per box)	Outer Diameter (mm)	Screw Dimension	Screw Height (mm)	Qty Per Box (pcs)	Weight (g)
329-1979	TPB20-5R	1,004THB	20	M5 x 0.80	10	20	100
329-1987	TPB20-6R	1,004THB	20	M6 x 1.00	10	20	100
329-1995	TPB25-6R	1,104THB	25	M6 x 1.00	14	20	200
329-2002	TPB25-8R	1,104THB	25	M8 x 1.25	14	20	200
329-2011	TPB32-8R	1,531THB	32	M8 x 1.25	14	20	400
329-2029	TPB32-10R	1,531THB	32	M10 x 1.50	20	20	400
329-2037	TPB40-10R	2,393THB	40	M10 x 1.50	20	20	800
329-2045	TPB40-12R	2,393THB	40	M12 x 1.75	20	20	800

TRUSCO



Gripping Ball (plastic)
P-TPB-BK P-TPB-R

ข้อมูลจำเพาะ ●แบบไม่มีแกน
วัสดุ ●เรซิน ABS
ประเทศที่ผลิต ●ญี่ปุ่น

Order Unit: 1 Pcs

TRUSCO NAKAYAMA CORPORATION

Order Code	Item No.	Price (per pcs)	Outer Diameter (mm)	Screw Dimension	Screw Height (mm)	Weight (g)
337-4017	P-TPB20-5BK	73THB	20	M5 x 0.80	10	5
337-4025	P-TPB20-6BK	73THB	20	M6 x 1.00	10	5
337-4033	P-TPB25-6BK	65THB	25	M6 x 1.00	14	10
337-4041	P-TPB25-8BK	65THB	25	M8 x 1.25	14	10
337-4050	P-TPB32-8BK	90THB	32	M8 x 1.25	14	20
337-4068	P-TPB32-10BK	90THB	32	M10 x 1.50	20	20
337-4076	P-TPB40-10BK	123THB	40	M10 x 1.50	20	40
337-4084	P-TPB40-12BK	123THB	40	M12 x 1.75	20	40

TRUSCO



Gripping Ball (plastic)
P-TPB-5R P-TPB-6R

ข้อมูลจำเพาะ ●แบบไม่มีแกน
วัสดุ ●เรซิน ABS
ประเทศที่ผลิต ●ญี่ปุ่น

Order Unit: 1 Pcs

TRUSCO NAKAYAMA CORPORATION

Order Code	Item No.	Price (per pcs)	Outer Diameter (mm)	Screw Dimension	Screw Height (mm)	Weight (g)
337-4092	P-TPB20-5R	73THB	20	M5 x 0.80	10	5
337-4106	P-TPB20-6R	73THB	20	M6 x 1.00	10	5
337-4114	P-TPB25-6R	65THB	25	M6 x 1.00	14	10
337-4122	P-TPB25-8R	65THB	25	M8 x 1.25	14	10
337-4131	P-TPB32-8R	90THB	32	M8 x 1.25	14	20
337-4149	P-TPB32-10R	90THB	32	M10 x 1.50	20	20
337-4157	P-TPB40-10R	123THB	40	M10 x 1.50	20	40
337-4165	P-TPB40-12R	123THB	40	M12 x 1.75	20	40

TRUSCO



Gripping Ball (aluminum)
TAB

ข้อมูลจำเพาะ ●แบบไม่มีแกน
วัสดุ ●อลูมิเนียมผสม
ประเทศที่ผลิต ●เยอรมนี

Order Unit: 1 Pcs

TRUSCO NAKAYAMA CORPORATION

Order Code	Item No.	Price (per pcs)	Outer Diameter (mm)	Screw Dimension	Screw Height (mm)	Weight (g)
329-2215	TAB-16	493THB	16	M4 x 0.70	7.2	5
329-2223	TAB-20	510THB	20	M5 x 0.80	9.1	10
329-2231	TAB-25	734THB	25	M6 x 1.00	11.0	20
329-2240	TAB-32	1,006THB	32	M8 x 1.25	14.5	45
329-2258	TAB-40	1,453THB	40	M10 x 1.50	18.0	85

TRUSCO



Gripping Ball (stainless steel)
TSB

ข้อมูลจำเพาะ ●แบบไม่มีแกน
วัสดุ ●เหล็กกล้าไร้สนิม (SUS304)
ประเทศที่ผลิต ●ญี่ปุ่น

Order Unit: 1 Pcs

TRUSCO NAKAYAMA CORPORATION

Order Code	Item No.	Price (per pcs)	Outer Diameter (mm)	Screw Dimension	Screw Height (mm)	Weight (g)
329-2134	TSB20-5S	861THB	20	M5 x 0.80	10	30
329-2142	TSB20-6S	861THB	20	M6 x 1.00	11	30
329-2151	TSB25-6S	967THB	25	M6 x 1.00	11	60
329-2169	TSB25-8S	967THB	25	M8 x 1.25	14	55
329-2177	TSB32-8S	1,149THB	32	M8 x 1.25	16	125
329-2185	TSB32-10S	1,149THB	32	M10 x 1.50	20	120
329-2193	TSB40-10S	1,571THB	40	M10 x 1.50	20	250
329-2207	TSB40-12S	1,571THB	40	M12 x 1.75	24	240

รหัสสั่งซื้อ **สีน้ำเงิน** ... มีสินค้าสต็อกที่ประเทศอินโดนีเซียและประเทศไทย **สีแดง** ... มีสินค้าสต็อกที่ประเทศอินโดนีเซีย **สีเขียว** ... มีสินค้าสต็อกที่ประเทศไทย

- O-Rings·Oil Seals
- Rubbers
- Resins
- Metal Materials
- Vibration Absorber
- Adjusters
- Plungers
- Springs for Die
- Springs
- Split Pins
- Snap Rings
- Oil Gauges
- Oil Tank Caps
- Knobs
- Lever
- Grip Handles
- Handles
- Hinges
- Slide Rails
- Stays
- Toggle Latches
- Fastening Parts
- Aluminum Frames

355 Machine Parts



- O-Rings· Oil Seals
- Rubbers
- Resins
- Metal Materials
- Vibration Absorber
- Adjusters
- Plungers
- Springs for Die
- Springs
- Split Pins
- Snap Rings
- Oil Gauges
- Oil Tank Caps
- Knobs
- Lever
- Grip Handles
- Handles
- Hinges
- Slide Rails
- Stays
- Toggle Latches
- Fastening Parts
- Aluminum Frames

TRUSCO
RoHS

Com Drawing

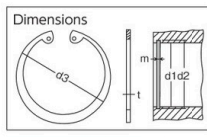

B91 Type

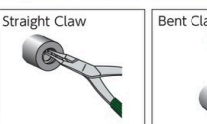
Snap Ring (for hole, stainless steel)

คุณสมบัติ ● ที่ทางปลา (มีรูสำหรับคีมจับ) ทำให้ง่ายต่อการใส่และถอด
วัสดุ ● เหล็กกล้าไร้สนิม (SUS304CSP)
ประเทศที่ผลิต ● ญี่ปุ่น

Order Unit: 1 Pack

TRUSCO NAKAYAMA CORPORATION

Order Code	Item No.	Price (per pack)	Nominal Diameter	Retaining Ring (mm)		Applicable Hole (reference) (mm)			Qty Per Pack (pcs)	Weight (g)
				d3	t	d1	d2	m		
161-0473	B91-0008	192THB	R-8	8.8	0.40	8	8.4	0.50	17	1.7
161-0490	B91-0010	192THB	R-10	10.7	1.00	10	10.4	1.15	16	4.3
161-0503	B91-0011	192THB	R-11	11.8	1.00	11	11.4	1.15	15	4.8
163-1705	B91-0012	192THB	R-12	13.0	1.00	12	12.5	1.15	15	6.0
163-1713	B91-0013	192THB	R-13	14.1	1.00	13	13.6	1.15	14	6.1
161-0546	B91-0014	192THB	R-14	15.1	1.00	14	14.6	1.15	13	6.2
161-0554	B91-0015	192THB	R-15	16.2	1.00	15	15.7	1.15	13	7.3
161-0562	B91-0016	192THB	R-16	17.3	1.00	16	16.8	1.15	12	7.3
161-0571	B91-0017	192THB	R-17	18.3	1.00	17	17.8	1.15	12	7.8
161-0589	B91-0018	192THB	R-18	19.5	1.00	18	19.0	1.15	12	9.1
161-0597	B91-0019	192THB	R-19	20.5	1.00	19	20.0	1.15	11	9.1
161-0601	B91-0020	192THB	R-20	21.5	1.00	20	21.0	1.15	11	9.3
161-0619	B91-0021	192THB	R-21	22.5	1.00	21	22.0	1.15	10	9.4
161-0627	B91-0022	192THB	R-22	23.5	1.00	22	23.0	1.15	9	8.9
161-0635	B91-0024	192THB	R-24	25.9	1.20	24	25.2	1.35	8	10.5
161-0643	B91-0025	192THB	R-25	26.9	1.20	25	26.2	1.35	8	11.7
161-0651	B91-0026	192THB	R-26	27.9	1.20	26	27.2	1.35	7	11.5
161-0660	B91-0028	192THB	R-28	30.1	1.20	28	29.4	1.35	7	12.1
161-0678	B91-0030	192THB	R-30	32.1	1.20	30	31.4	1.35	6	11.0
161-0686	B91-0032	192THB	R-32	34.4	1.20	32	33.7	1.35	5	11.6
161-0694	B91-0034	192THB	R-34	36.5	1.50	34	35.7	1.65	4	12.4
161-0708	B91-0035	192THB	R-35	37.8	1.50	35	37.0	1.65	4	12.8
161-0716	B91-0036	192THB	R-36	38.8	1.50	36	38.0	1.65	4	13.2
161-0724	B91-0037	192THB	R-37	39.8	1.50	37	39.0	1.65	3	10.3
161-0732	B91-0038	192THB	R-38	40.8	1.50	38	40.0	1.65	3	11.4
161-0741	B91-0040	192THB	R-40	43.5	1.75	40	42.5	1.90	2	9.9
161-0759	B91-0042	192THB	R-42	45.5	1.75	42	44.5	1.90	2	10.3
161-0767	B91-0045	192THB	R-45	48.5	1.75	45	47.5	1.90	2	12.5
161-0775	B91-0047	192THB	R-47	50.5	1.75	47	49.5	1.90	1	6.8
161-0783	B91-0048	192THB	R-48	51.5	1.75	48	50.5	1.90	1	7.0
161-0791	B91-0050	192THB	R-50	54.2	2.00	50	53.0	2.20	1	8.2

- Grip Handles
- Handles
- Hinges
- Slide Rails
- Stays
- Toggle Latches
- Fastening Parts
- Aluminum Frames

KOHO
RoHS



HM-V Series

"Oil Pot Window"

คุณสมบัติ ● แผ่นสะท้อนแสงเป็นสีขาวและจะเห็นตัวบั้งซี่ Hinomaru ซึ่งจะเห็นชัดเจนแม้ในที่ค่อนข้างมืด
ข้อมูลจำเพาะ ● แบบขับเคลื่อน
● อุณหภูมิต้านทานความร้อน: 100°C
วัสดุ ● โพลีคาร์บอเนต (PC)
ประเทศที่ผลิต ● ญี่ปุ่น

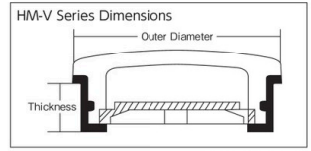

Order Unit: 1 Pcs

KOHOKOSAN

Order Code	Item No.	Price (per pcs)	Outer Diameter (mm)	Thickness (mm)	Mounting Hole Diameter (mm)	Weight (g)
102-8731	HM-VA-01	188THB	22.0	8.0	20.5	3
102-8740	HM-VA	233THB	32.0	8.0	28.0	7
102-8758	HM-VB	413THB	44.0	12.0	38.0	15
102-8766	HM-VC	527THB	50.0	12.0	46.0	22
102-8774	HM-VD	700THB	65.0	12.5	58.5	35
102-8782	HM-VE	1,009THB	80.0	14.0	74.0	57
102-9185	HM-W-25	128THB	25.5	9.0	25.0	4

- Oil Level Gauges

MUSASHI
RoHS



OLG-50N

ข้อมูลจำเพาะ ● แบบขับเคลื่อน
● อุณหภูมิต้านทานความร้อน: 100°C
วัสดุ ● โพลีคาร์บอเนต (PC)
ประเทศที่ผลิต ● ญี่ปุ่น

Order Unit: 1 Pcs

MUSASHI OIL SEAL MFG.Co.Ltd

Order Code	Item No.	Price (per pcs)	Outer Diameter (mm)	Thickness (mm)	Mounting Hole Diameter (mm)	Weight (g)
310-3005	OLG-20N	178THB	20	7	20	5.4
310-3021	OLG-25N	237THB	25	7	25	8.3
310-3048	OLG-30N	277THB	30	8	30	12.9
310-3064	OLG-35N	386THB	35	8	35	16.3
310-3081	OLG-40N	420THB	40	10	40	22.2
310-3099	OLG-45N	891THB	45	10	45	28.8
310-3102	OLG-50N	974THB	50	12	50	38.5

KOHO
RoHS



N-1

ข้อมูลจำเพาะ ● แบบเกลียว
● อุณหภูมิต้านทานความร้อน: 100°C
วัสดุ ● โพลีคาร์บอเนต (PC)
ประเทศที่ผลิต ● ญี่ปุ่น

Order Unit: 1 Pcs

KOHOKOSAN

Order Code	Item No.	Price (per pcs)	Width (mm)	Width Across-Flat Dimension (mm)	Thickness (mm)	Mounting Hole Diameter (mm)	Weight (g)
102-9339	N-01	172THB	22	19.0	10	1/4PF	3
102-9347	N-1	202THB	26	23.0	10	3/8PF	5
102-9355	N-2	317THB	31	27.5	15	1/2PF	8
102-9363	N-3	380THB	38	33.5	15	3/4PF	12
102-9371	N-4	519THB	49	43.0	18	1PF	19
102-9380	N-5	593THB	57	50.0	20	1 1/4PF	29

355

สินค้าบางรายการไม่สามารถนำเข้าได้ สินค้าบางรายการไม่สามารถใช้กับไฟไทยได้ ราคาไม่รวมภาษีมูลค่าเพิ่ม

325 Machine Parts

- O-Rings
Oil
Seals
- Rubbers
- Resins
- Metal
Materials
- Vibration
Absorber
- Adjusters
- Plungers
- Springs
for
Die
- Springs
- Split
Pins
- Snap
Rings
- Oil
Gauges
- Oil
Tank
Caps
- Knobs
- Lever
- Grip
Handles
- Handles
- Hinges
- Slide
Rails
- Stays
- Toggle
Latches
- Fastening
Parts
- Aluminum
Frames



1A-P Type

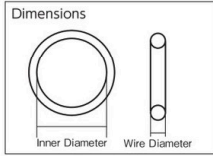

Example



O-ring (both moving and fixed)

คุณสมบัติ ● โอริงที่ทำจากยางสังเคราะห์ ถูกสร้างขึ้นเพื่อป้องกันการรั่วไหลของเหลว เช่น น้ำมัน และ น้ำ เท่านั้น แต่ยังสามารถป้องกันของไหลอื่น ๆ หลายชนิด เช่น อากาศ และ แก๊ส สำหรับทำหน้าที่ป้องกันของมันอย่างเต็มที่โดยใช้ความเครียดจากการอัดที่พอเหมาะ

ข้อมูลจำเพาะ ● สำหรับเคลื่อนที่/อยู่กับที่
● ผลิตภัณฑ์มาตรฐาน JIS B 2401
● ช่วงอุณหภูมิทำงาน: 0 ถึง 80°C

วัสดุ ● แบบ 1 A ยางไนไตรล์ (NBR)

ประเทศที่ผลิต ● ญี่ปุ่น

Order Unit: 1 Pack							Akitsu Industry Co.Ltd.						
Order Code	Item No.	Price (per pack)	Inner Diameter (mm)	Wire Diameter (mm)	Q'ty Per Pack (pcs)	Weight (g)	Order Code	Item No.	Price (per pack)	Inner Diameter (mm)	Wire Diameter (mm)	Q'ty Per Pack (pcs)	Weight (g)
219-4970	1A-P3	103THB	2.8	1.9	10	1.0	219-5381	1A-P42	212THB	41.7	3.5	5	8.5
219-4988	1A-P4	103THB	3.8	1.9	10	1.0	219-5399	1A-P44	199THB	43.7	3.5	5	9.0
219-4996	1A-P5	103THB	4.8	1.9	10	1.0	219-5402	1A-P45	219THB	44.7	3.5	5	9.0
219-5003	1A-P6	119THB	5.8	1.9	10	1.0	219-5411	1A-P46	219THB	45.7	3.5	5	9.5
219-5011	1A-P7	108THB	6.8	1.9	10	1.0	219-5429	1A-P48	246THB	47.7	3.5	5	10.0
219-5020	1A-P8	108THB	7.8	1.9	10	1.0	219-5437	1A-P48A	246THB	47.6	5.7	5	26.0
219-5038	1A-P9	116THB	8.8	1.9	10	1.0	219-5445	1A-P49	246THB	48.7	3.5	5	10.0
219-5046	1A-P10	116THB	9.8	1.9	10	2.0	219-5453	1A-P50	273THB	49.7	3.5	5	16.5
219-5054	1A-P10A	128THB	9.8	2.4	10	2.0	219-5461	1A-P50A	273THB	49.6	5.7	5	27.0
219-5062	1A-P11	128THB	10.8	2.4	10	2.0	219-5470	1A-P52	150THB	51.6	5.7	2	11.2
219-5071	1A-P11.2	140THB	11.0	2.4	10	2.0	219-5488	1A-P53	150THB	52.6	5.7	2	11.4
219-5089	1A-P12	143THB	11.8	2.4	10	2.0	219-5496	1A-P55	150THB	54.6	5.7	2	11.8
219-5097	1A-P12.5	143THB	12.3	2.4	10	2.0	219-5500	1A-P56	162THB	55.6	5.7	2	12.2
219-5101	1A-P14	130THB	13.8	2.4	10	3.0	219-5518	1A-P58	162THB	57.6	5.7	2	12.4
219-5119	1A-P15	138THB	14.8	2.4	10	3.0	219-5526	1A-P60	148THB	59.6	5.7	2	13.0
219-5127	1A-P16	150THB	15.8	2.4	10	3.0	219-5534	1A-P62	162THB	61.6	5.7	2	13.4
219-5135	1A-P18	150THB	17.8	2.4	10	3.0	219-5542	1A-P63	165THB	62.6	5.7	2	13.6
219-5143	1A-P20	148THB	19.8	2.4	10	4.0	219-5551	1A-P65	165THB	64.6	5.7	2	14.0
219-5151	1A-P21	148THB	20.8	2.4	10	4.0	219-5569	1A-P67	165THB	66.6	5.7	2	14.4
219-5160	1A-P22	162THB	21.8	2.4	10	4.0	219-5577	1A-P70	165THB	69.6	5.7	2	15.2
219-5178	1A-P22A	212THB	21.7	3.5	10	9.0	219-5585	1A-P71	175THB	70.6	5.7	2	15.4
219-5186	1A-P22.4	212THB	22.1	3.5	10	9.0	219-5593	1A-P75	159THB	74.6	5.7	2	16.2
219-5194	1A-P24	212THB	23.7	3.5	10	9.0	219-5607	1A-P80	175THB	79.6	5.7	2	17.4
219-5208	1A-P25	193THB	24.7	3.5	10	10.0	219-5615	1A-P85	190THB	84.6	5.7	2	18.4
219-5216	1A-P25.5	229THB	25.2	3.5	10	10.0	219-5623	1A-P90	173THB	89.6	5.7	2	19.6
219-5224	1A-P26	209THB	25.7	3.5	10	11.0	219-5631	1A-P95	206THB	94.6	5.7	2	20.6
219-5232	1A-P28	240THB	27.7	3.5	10	11.0	219-5640	1A-P100	138THB	99.6	5.7	1	10.8
219-5241	1A-P29	263THB	28.7	3.5	10	12.0	219-5658	1A-P102	138THB	101.6	5.7	1	11.1
219-5259	1A-P29.5	263THB	29.2	3.5	10	12.0	219-5666	1A-P105	150THB	104.6	5.7	1	11.4
219-5267	1A-P30	280THB	29.7	3.5	10	12.0	219-5674	1A-P110	150THB	109.6	5.7	1	12.0
219-5275	1A-P31	175THB	30.7	3.5	5	6.5	243-6574	1A-P112.0	150THB	111.6	5.7	1	12.1
219-5283	1A-P31.5	175THB	31.2	3.5	5	6.5	219-5691	1A-P115	150THB	114.6	5.7	1	12.5
219-5291	1A-P32	192THB	31.7	3.5	5	6.5	219-5704	1A-P120	168THB	119.6	5.7	1	13.0
219-5305	1A-P34	175THB	33.7	3.5	5	7.0	243-6582	1A-P125.0	168THB	124.6	5.7	1	13.6
219-5313	1A-P35	192THB	34.7	3.5	5	7.0	219-5721	1A-P130	168THB	129.6	5.7	1	14.1
219-5321	1A-P35.5	202THB	35.2	3.5	5	7.0	219-5739	1A-P132	179THB	131.6	5.7	1	14.3
219-5330	1A-P36	185THB	35.7	3.5	5	7.5	219-5747	1A-P135	179THB	134.6	5.7	1	15.0
219-5348	1A-P38	185THB	37.7	3.5	5	7.5	219-5755	1A-P140	179THB	139.6	5.7	1	15.2
219-5356	1A-P39	202THB	38.7	3.5	5	8.0	219-5763	1A-P145	198THB	144.6	5.7	1	15.7
219-5364	1A-P40	212THB	39.7	3.5	5	8.0	219-5771	1A-P150	198THB	149.6	5.7	1	16.3
219-5372	1A-P41	212THB	40.7	3.5	5	8.5							

MORISEI KAKO

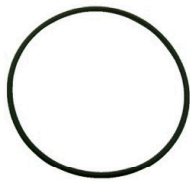

1A-G Type

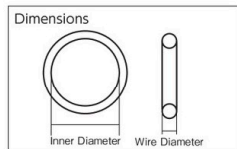

Example

O-ring (for fixing)

คุณสมบัติ ● มีความต้านทานน้ำมันและการสึกหรอเป็นเลิศ และความทนทานต่อความร้อนที่

ข้อมูลจำเพาะ ● สำหรับยึดอยู่กับที่
● ผลิตภัณฑ์มาตรฐาน JIS B 2401
● ช่วงอุณหภูมิทำงาน: -30 ถึง 100°C

วัสดุ ● แบบ 1 A ยางไนไตรล์ (NBR)

ประเทศที่ผลิต ● ญี่ปุ่น

Order Unit: 1 Pack							MORISEI KAKO Co.Ltd.						
Order Code	Item No.	Price (per pack)	Inner Diameter (mm)	Wire Diameter (mm)	Q'ty Per Pack (pcs)	Weight (g)	Order Code	Item No.	Price (per pack)	Inner Diameter (mm)	Wire Diameter (mm)	Q'ty Per Pack (pcs)	Weight (g)
295-6624	1A-G25	103THB	24.4	3.1	10	104.0	298-1769	1A-G90	62THB	89.4	3.1	2	15.2
295-6632	1A-G30	138THB	29.4	3.1	10	120.0	298-1777	1A-G95	79THB	94.4	3.1	2	16.0
295-6641	1A-G35	69THB	34.4	3.1	5	39.0	295-6527	1A-G100	40THB	99.4	3.1	1	5.0
295-6659	1A-G40	95THB	39.4	3.1	5	42.0	295-6535	1A-G105	40THB	104.4	3.1	1	5.2
295-6667	1A-G45	95THB	44.4	3.1	5	46.5	295-6543	1A-G110	42THB	109.4	3.1	1	5.4
295-6675	1A-G50	103THB	49.4	3.1	5	50.0	295-6551	1A-G115	42THB	114.4	3.1	1	5.7
298-1696	1A-G55	42THB	54.4	3.1	2	11.0	295-6560	1A-G120	52THB	119.4	3.1	1	5.7
298-1700	1A-G60	45THB	59.4	3.1	2	11.6	295-6578	1A-G125	52THB	124.4	3.1	1	6.0
298-1718	1A-G65	48THB	64.4	3.1	2	12.0	295-6586	1A-G130	59THB	129.4	3.1	1	6.0
298-1726	1A-G70	59THB	69.4	3.1	2	12.8	295-6594	1A-G135	59THB	134.4	3.1	1	6.3
298-1734	1A-G75	59THB	74.4	3.1	2	13.4	295-6608	1A-G140	65THB	139.4	3.1	1	6.3
298-1742	1A-G80	62THB	79.4	3.1	2	14.0	295-6616	1A-G145	65THB	144.4	3.1	1	6.3
298-1751	1A-G85	62THB	84.4	3.1	2	14.6	298-1785	1A-G150	109THB	149.3	5.7	1	17.5

325

สินค้าบางรายการไม่สามารถนำเข้าได้ สินค้าบางรายการไม่สามารถใช้กับไฟฟ้าไทยได้ ราคาไม่รวมภาษีมูลค่าเพิ่ม

331 Machine Parts

- O-Rings·Oil Seals
- Rubbers
- Resins
- Metal Materials
- Vibration Absorber
- Adjusters
- Plungers
- Springs for Die
- Springs
- Split Pins
- Snap Rings
- Oil Gauges
- Oil Tank Caps
- Knobs
- Lever
- Grip Handles
- Handles
- Hinges
- Slide Rails
- Stays
- Toggle Latches
- Fastening Parts
- Aluminum Frames

INOAC

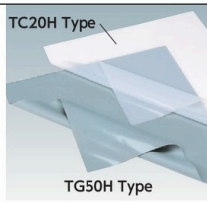

TC20H Type
TG50H Type

TRUSCO

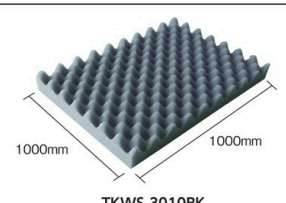

TKWS-3010BK

RoHS

Silicone Rubber Insulation and Heat Resistant Sheet Wavy Shaped Sponge Sheet (soft type)

คุณสมบัติ ●มีคุณสมบัติทนน้ำมัน ทนสารเคมี ทนอากาศ และไม่ลามไฟที่ดีเยี่ยม
 ข้อมูลจำเพาะ ●ช่วงอุณหภูมิทำงาน: -40 ถึง 200°C
 วัสดุ ●ยางซิลิโคน ประเทศที่ผลิต ●ญี่ปุ่น

คุณสมบัติ ●เหมาะสำหรับเป็นวัสดุรับแรงกระแทกเนื่องจากมีความอ่อน
 ข้อมูลจำเพาะ ●ช่วงอุณหภูมิทำงาน: -20 ถึง 70°C ●ความหนาแน่น: 22 กก./m³
 วัสดุ ●โฟมยูรีเทน ประเทศที่ผลิต ●ญี่ปุ่น

INOAC CORPORATION

Order Code	Item No.	Price (per sheet)	Color	Thickness (mm)	Width (mm)	Length (mm)	Weight (g)
219-2519	TC20H100T	6,344THB	Transparent	1.0	500	500	450
219-2527	TG50H050T	4,267THB	Gray	0.5	500	500	210
219-2535	TG50H100T	5,413THB	Gray	1.0	500	500	420

TRUSCO NAKAYAMA CORPORATION

Order Code	Item No.	Price (per sheet)	Thickness (mm)	Width (mm)	Length (mm)	Weight (g)
764-3101	TKWS-2010BK	817THB	20	1000	1000	330
764-3110	TKWS-3010BK	1,173THB	30	1000	1000	495
764-3128	TKWS-4010BK	1,541THB	40	1000	1000	660

TRUSCO

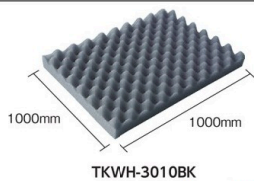

TKWH-3010BK

RoHS

INOAC



EAS Type

Item No.	Volume Resistivity (Ω/cm)
EAS-2	5.3 x 10 ¹⁰
EAS-3	2.5 x 10 ¹⁰

Wavy Shaped Sponge Sheet (hard type)

คุณสมบัติ ●เหมาะสำหรับเป็นวัสดุรับแรงกระแทกเนื่องจากมีความอ่อน
 ข้อมูลจำเพาะ ●ช่วงอุณหภูมิทำงาน: -20 ถึง 70°C
 ●ความหนาแน่น: 25 กก./m³
 วัสดุ ●โฟมยูรีเทน ประเทศที่ผลิต ●ญี่ปุ่น

Urethane Foam Sheet Material "Ohmeflex"

คุณสมบัติ ●วัสดุดีสำหรับป้องกันไฟฟ้าสถิต
 ●มีการกันกระแทกที่ช่วยบรรเทาแรงดึงเครียดจากการอัดที่ค้างอยู่
 ข้อมูลจำเพาะ ●ช่วงอุณหภูมิทำงาน: -20 ถึง 70°C
 วัสดุ ●โฟมยูรีเทน ประเทศที่ผลิต ●ญี่ปุ่น

TRUSCO NAKAYAMA CORPORATION

Order Code	Item No.	Price (per sheet)	Thickness (mm)	Width (mm)	Length (mm)	Weight (g)
764-3071	TKWH-2010BK	996THB	20	1000	1000	375
764-3080	TKWH-3010BK	1,421THB	30	1000	1000	563
764-3098	TKWH-4010BK	1,876THB	40	1000	1000	750

INOAC CORPORATION

Order Code	Item No.	Price (per sheet)	Thickness (mm)	Width (mm)	Length (mm)	Weight (g)
417-2442	EAS-2	1,323THB	10	1000	1000	300
417-2451	EAS-3	2,116THB	10	1000	1000	550

INOAC

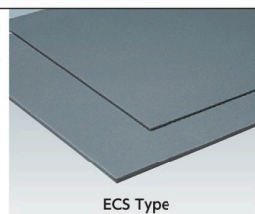

ECS Type

INOAC

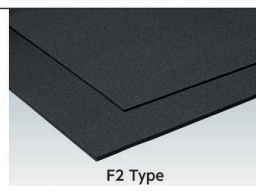

F2 Type

Urethane Foam Cushioning Sheet

คุณสมบัติ ●เป็นกันกระแทกที่ช่วยลดเสียงและสั่นไหวหนักเบา
 ข้อมูลจำเพาะ ●ช่วงอุณหภูมิทำงาน: -20 ถึง 70°C ●ความหนาแน่น: 22 กก./m³
 วัสดุ ●โฟมยูรีเทน (ชนิดอีเธอร์) ประเทศที่ผลิต ●ญี่ปุ่น

Urethane Foam Sound Absorbing Material "Calmflex F2"

คุณสมบัติ ●ดูดเสียงของการสั่นสะเทือนในอากาศ ●ความหนาที่เพิ่มขึ้นทำให้ดูดซับเสียงได้ดียิ่งขึ้น
 ข้อมูลจำเพาะ ●ได้รับการรับรองคุณสมบัติติดไฟตาม UL94 HF-1
 ●ช่วงอุณหภูมิทำงาน: -20 ถึง 70°C ●ความหนาแน่น: 25 กก./m³
 วัสดุ ●โฟมยูรีเทน ประเทศที่ผลิต ●ญี่ปุ่น

INOAC CORPORATION

Order Code	Item No.	Price (per sheet)	Thickness (mm)	Width (mm)	Length (mm)	Weight (g)
219-2136	ECS10	342THB	10	1000	1000	220
219-2144	ECS20	677THB	20	1000	1000	440

INOAC CORPORATION

Order Code	Item No.	Price (per sheet)	Thickness (mm)	Width (mm)	Length (mm)	Weight (g)
219-2152	F2-10	503THB	10	1000	1000	250
219-2161	F2-20	991THB	20	1000	1000	500
417-2469	F2-30	1,509THB	30	1000	1000	750

INOAC

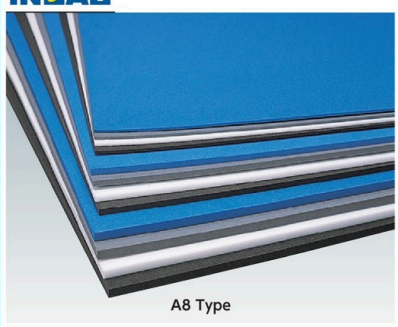

A8 Type

Gray (GR) Black (BK) Blue (BL)

Foamed Polyethylene Working Sheet

คุณสมบัติ ●ยึดเหนี่ยวเรื่องความสามารถในการสร้างรูป และเหมาะสำหรับจัดเก็บแผ่น
 ●เหนือกว่า เรื่องความทนทานต่อสภาพพื้นฟ้าอากาศ ฉนวนความร้อน ความทนทานต่อสารเคมี และฉนวนกันความเย็น
 ข้อมูลจำเพาะ ●ช่วงอุณหภูมิทำงาน: -20 ถึง 70°C
 ●ความหนาแน่น: 65 กก./m³
 วัสดุ ●โฟมโพลีเอทิลีน (PE เบา)
 ประเทศที่ผลิต ●ญี่ปุ่น

INOAC CORPORATION

Order Code	Item No.	Price (per sheet)	Color	Thickness (mm)	Width (mm)	Length (mm)	Weight (g)
219-2322	A8-051GR	761THB	Gray	5	1000	1000	325
219-2331	A8-101GR	1,306THB	Gray	10	1000	1000	650
219-2349	A8-151GR	1,851THB	Gray	15	1000	1000	975
219-2381	A8-051BK	761THB	Black	5	1000	1000	325
219-2403	A8-151BK	1,851THB	Black	15	1000	1000	975
219-2411	A8-051BL	761THB	Blue	5	1000	1000	325
219-2438	A8-101BL	1,306THB	Blue	10	1000	1000	650
219-2462	A8-151BL	1,851THB	Blue	15	1000	1000	975

329 Machine Parts

O-Rings
Oil
Seals

HIKARI



Rubbers

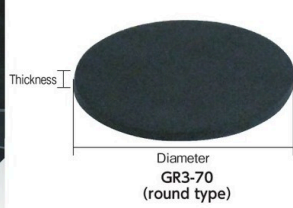
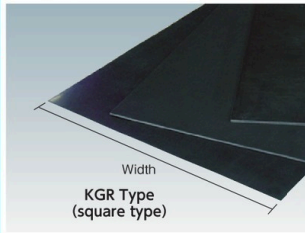

Square Type

Order Unit: 1 Sheet

HIKARI Co.Ltd.

Order Code	Item No.	Price (per sheet)	Thickness (mm)	Width (mm)	Length (mm)	Weight (g)
412-2445	KGR-1100	23THB	1	100	100	16
412-2461	KGR-1200	65THB	1	200	200	59
361-0659	KGR-1300	158THB	1	300	300	120
412-2470	KGR-2100	25THB	2	100	100	28
412-2496	KGR-2200	72THB	2	200	200	129
361-0675	KGR-2300	165THB	2	300	300	250
412-2500	KGR-3100	30THB	3	100	100	49
412-2526	KGR-3200	79THB	3	200	200	199
361-0691	KGR-3300	178THB	3	300	300	430
412-2534	KGR-5100	35THB	5	100	100	64
412-2542	KGR-5200	126THB	5	200	200	228
412-2551	KGR-5300	273THB	5	300	300	630
412-2411	KGR10-10	72THB	10	100	100	150
412-2429	KGR10-20	247THB	10	200	200	616
412-2437	KGR10-30	597THB	10	300	300	1352

Adjusters

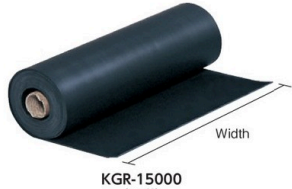

KGR-15000 (Roll)

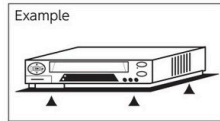

Example

Plungers

Springs for Die

Springs

Split Pins

Natural Rubber Plate

การใช้งาน ●วัสดุปะเก็น, แผ่นกันลื่น, เสื่อดูดซับการสั่นสะเทือน
ข้อมูลจำเพาะ ●ช่วงอุณหภูมิทำงาน: -30 ถึง 70°C ●สี: ดำ
วัสดุ ●ยางธรรมชาติ (NR) ประเทศที่ผลิต ●ญี่ปุ่น

Round Type

Order Unit: 1 Sheet

Order Code	Item No.	Price (per sheet)	Thickness (mm)	Diameter (mm)	Weight (g)
412-2330	GR3-50	28THB	3	50	10
412-2348	GR3-70	32THB	3	70	20
788-6292	GR3-100	52THB	3	100	34
412-2364	GR5-50	28THB	5	50	15
412-2381	GR5-70	35THB	5	70	30
788-6331	GR5-100	76THB	5	100	59

Roll

Order Unit: 1 Roll

Order Code	Item No.	Price (per roll)	Thickness (mm)	Width (mm)	Length (mm)	Weight (g)
361-0641	KGR-1101	86THB	1	50	1000	70
412-2453	KGR-1102	158THB	1	100	1000	144
473-9329	GR1-1001-T	1,966THB	1	100	10000	1580
473-9337	GR1-3001-T	5,896THB	1	300	10000	5340
397-6823	KGR-15000	7,533THB	1	500	10000	8000
473-9311	GR1-1000-T	12,970THB	1	1000	10000	18850
361-0667	KGR-2101	95THB	2	50	1000	152
412-2488	KGR-2102	165THB	2	100	1000	303
361-0683	KGR-3101	99THB	3	50	1000	240
412-2518	KGR-3102	172THB	3	100	1000	495
473-9353	GR3-1001-T	1,374THB	3	100	5000	2380
473-9361	GR3-3001	4,126THB	3	300	5000	6480
397-6831	KGR-35000	4,586THB	3	500	5000	12000
473-9345	GR3-1000-T	7,700THB	3	1000	5000	23000
412-2372	GR5-51	178THB	5	50	1000	363
412-2356	GR5-101	353THB	5	100	1000	778
473-9370	GR5-3001-T	4,911THB	5	300	5000	11140
473-9388	GR5-500-T	6,879THB	5	500	5000	20150

Snap Rings

Oil Gauges

Oil Tank Caps

Knobs

Lever

Grip Handles

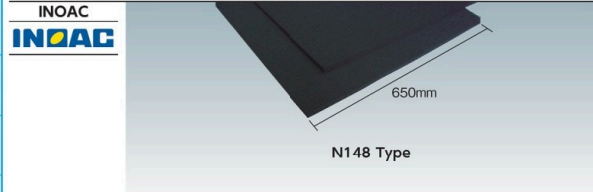

N148 Type

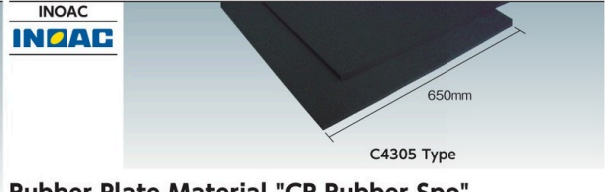

C4305 Type

Handles

Hinges

Slide Rails

Rubber Plate "Natural Rubber Sponge"

คุณสมบัติ ●มีความยืดหยุ่นสูง ทนต่อการเสียดสี ทนต่อการกัดกร่อนและทนต่อการฉีกขาด

ข้อมูลจำเพาะ ●ช่วงอุณหภูมิทำงาน: -40 ถึง 110°C ●ความหนาแน่น: 0.100±0.03 ก./ซม.³
วัสดุ ●ยางโฟม (ธรรมชาติ) ประเทศที่ผลิต ●ญี่ปุ่น

Order Unit: 1 Sheet

INOAC CORPORATION

Order Code	Item No.	Price (per sheet)	Thickness (mm)	Width (mm)	Length (m)	Weight (g)
417-2485	N148-5	1,407THB	5	650	1	487
417-2477	N148-10	2,560THB	10	650	1	975

Rubber Plate Material "CR Rubber Spo"

คุณสมบัติ ●มีความทนทานต่อน้ำมันและความทนทานต่อความร้อนปานกลาง และมีความทนทานต่อสภาพดินฟ้าอากาศดีเยี่ยม มีความทนทานต่อไอโซนและติดไฟช้า

ข้อมูลจำเพาะ ●ช่วงอุณหภูมิทำงาน: -20 ถึง 100°C ●ความหนาแน่น: 0.190±0.03 ก./ซม.³
วัสดุ ●ยางโฟม (แบบ CR) ประเทศที่ผลิต ●ญี่ปุ่น

Order Unit: 1 Sheet

INOAC CORPORATION

Order Code	Item No.	Price (per sheet)	Thickness (mm)	Width (mm)	Length (m)	Weight (kg)
417-2400	C4305-5	1,483THB	5	650	1	0.618
417-2396	C4305-10	2,693THB	10	650	1	1.235

Fastening Parts

Aluminum Frames

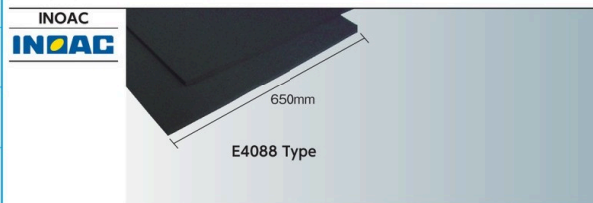

E4088 Type



NBRG Type

Rubber Plate Material "EPDM Rubber Sponge"

คุณสมบัติ ●มีความยืดหยุ่นสูง ทนต่อการเสียดสี ทนต่อการกัดกร่อนและทนต่อการฉีกขาด

ข้อมูลจำเพาะ ●ช่วงอุณหภูมิทำงาน: -40 ถึง 110°C ●ความหนาแน่น: 0.100±0.03 ก./ซม.³
วัสดุ ●ยางโฟม (ชนิด EPDM) ประเทศที่ผลิต ●ญี่ปุ่น

Order Unit: 1 Sheet

INOAC CORPORATION

Order Code	Item No.	Price (per sheet)	Thickness (mm)	Width (mm)	Length (m)	Weight (g)
417-2426	E4088-5	1,291THB	5	650	1	325
417-2418	E4088-10	2,304THB	10	650	1	650

NBR Rubber Board

คุณสมบัติ ●ยางที่มีความต้านทานต่อไขมันและการเสียดสีเยี่ยม (ไม่มีส่วนผสมของสารพลาสติไซเซอร์)

ข้อมูลจำเพาะ ●ช่วงอุณหภูมิทำงาน: 0 ถึง 80°C
วัสดุ ●ยางไนไตรล์บิวทาไดอิน (NBR) ประเทศที่ผลิต ●ญี่ปุ่น

Order Unit: 1 Sheet

Akitsu Industry Co.Ltd.

Order Code	Item No.	Price (per sheet)	Thickness (mm)	Width (mm)	Length (mm)	Weight (g)
385-1737	NBRG300X300-1	280THB	1	300	300	120
385-1745	NBRG300X300-2	439THB	2	300	300	240
385-1753	NBRG300X300-3	526THB	3	300	300	370